

Primo™ system



Compliance information for this product is available by scanning the QR code or visiting www.renishaw.com/mtpdoc



Contents

Before you begin 1-1

Warranty 1-1

CNC machines 1-1

Care of the probe 1-1

Patents 1-1

Intended use 1-2

Safety 1-3

 Information to the user 1-3

 Information to the machine supplier/ installer 1-4

 Information to the equipment installer 1-4

Equipment operation 1-4

Renishaw GoProbe cycles 1-4

GoProbe training kit 1-5

Primo™ radio part setter and Primo™ radio 3D tool setter basics 2-1

Introduction 2-1

 Getting started 2-1

 Credit 2-1

 Modes of operation 2-1

Configurable settings 2-2

 Tool setter switch-on/switch-off 2-2

 Enhanced trigger filter 2-2

Recalibration 2-2

Acquisition mode 2-3

Primo credit token 2-3

 Primo upgrade credit token 2-3

 Credit transfer 2-3

 How to purchase a credit token 2-3

 Low credit indicators 2-4

Part setter operation 2-4

Tool setter operation 2-5

Software routines 2-6

Primo™ interface basics 3-1

Introduction 3-1

 Power supply 3-1

 Interface visual diagnostics 3-2

Interface inputs 3-2

Interface outputs	3-2
SSR outputs specifications	3-3
Interface output waveform	3-3
Signal delays:	3-3
Switches SW1 and SW2.	3-4
Switch SW1 output configuration	3-5
Switch SW2 output configuration	3-5
Dimensions and specifications	4-1
Part setter dimensions	4-1
Tool setter dimensions	4-2
Interface dimensions	4-3
Part setter specification	4-4
Typical battery life	4-4
Tool setter specification	4-5
Typical battery life	4-5
Interface specification	4-6
System installation	5-1
Operating envelope	5-1
Signal LED	5-1
Performance envelopes	5-2
Equipment positioning	5-2
Preparing the part setter.	5-3
Fitting the stylus	5-3
Installing the battery	5-4
Mounting the part setter on a shank.	5-5
Part setter stylus on-centre adjustment	5-6
Preparing the tool setter for use	5-7
Fitting the stylus, break stem and captive link	5-7
Installing the battery	5-8
Mounting the tool setter on a machine table	5-9
Tool setter stylus level setting.	5-10
Preparing the interface for use	5-12
Mounting bracket (optional)	5-12
Interface wiring diagram	5-13
Interface cable	5-14
Cable specification	5-14
Interface screw torque values.	5-15

Calibrating the Primo equipment	5-16
Why calibrate?	5-16
Calibrating the part setter and tool setter together	5-16
GoProbe training part calibration	5-17
Calibrating the part setter only	5-17
Calibrating in a bored hole or on a turned diameter	5-17
Calibrating in a ring gauge or on a datum sphere	5-17
Calibrating the probe length	5-17
Calibrating the tool setter only	5-18
Part setter and tool setter LED guide	5-18
Start-up	5-18
Acquisition mode	5-18
Operational mode (all signals repeat)	5-19
Errors	5-19
Credit transfer mode (part setter only)	5-19
Interface LED signals	5-20
Acquisition mode	5-21
Operational mode	5-22
Error states	5-23
Error codes	5-24
Flashing codes	5-24
Interface digital display codes	5-24
Credit codes	5-24
Acquisition method	5-25
Part setter	5-25
Tool setter	5-27
Installing the credit token cassette	5-29
Changing the credit token	5-30
Credit transfer	5-32
Maintenance	6-1
Introduction	6-1
Cleaning the equipment	6-1
Changing the battery	6-2
Part setter	6-2
Tool setter	6-3
Interface cover	6-5
Removing the interface cover	6-5
Routine tool setter maintenance	6-6

Fault-finding7-1
Part setter.....7-1
Tool setter.....7-6
Interface7-10
Parts list8-1

Before you begin

Warranty

Unless you and Renishaw have agreed and signed a separate written agreement, the equipment and/or software are sold subject to the Renishaw Standard Terms and Conditions supplied with such equipment and/or software, or available on request from your local Renishaw office.

Renishaw warrants its equipment and software for a limited period (as set out in the Standard Terms and Conditions), provided that they are installed and used exactly as defined in associated Renishaw documentation. You should consult these Standard Terms and Conditions to find out the full details of your warranty.

Equipment and/or software purchased by you from a third-party supplier is subject to separate terms and conditions supplied with such equipment and/or software. You should contact your third-party supplier for details.

CNC machines

CNC machine tools must always be operated by fully trained personnel in accordance with the manufacturer's instructions.

Care of the probe

Keep system components clean and treat the probe as a precision tool.

Patents

Features of the Primo and features of similar Renishaw products, are the subject of one or more of the following patents and/or patent applications:

CN 100466003	IN 215787	US 10401162
CN 101354266	WO 2004/057552	US 6941671
CN 101482402	WO 2015/162431	US 7285935
CN 106471334	JP 4237051	US 7486195
EP 1425550	JP 4575781	US 7821420
EP 1457786	JP 5238749	US 8437978
EP 1576560	JP 5390719	US 8700351
EP 1804020	JP 5410700	US 9140547
EP 2019284	JP 6622216	
EP 2216761	KR 1001244	
EP 3134707	TW I380025	

Microchip software licensing agreement

This product's firmware has been developed by Renishaw with the use of the Microchip libraries, under the following licensing terms:

This software is developed by Microchip Technology Inc. and its subsidiaries ("Microchip"). Redistribution and use in source and binary forms, with or without modification, are permitted provided that the following conditions are met:

1. Redistributions of source code must retain the above copyright notice, this list of conditions and the following disclaimer.
2. Redistributions in binary form must reproduce the above copyright notice, this list of conditions and the following disclaimer in the documentation and/or other materials provided with the distribution.
3. Microchip's name may not be used to endorse or promote products derived from this software without specific prior written permission.

THIS SOFTWARE IS PROVIDED BY MICROCHIP "AS IS" AND ANY EXPRESS OR IMPLIED WARRANTIES, INCLUDING, BUT NOT LIMITED TO, THE IMPLIED WARRANTIES OF MERCHANTABILITY AND FITNESS FOR PURPOSE ARE DISCLAIMED. IN NO EVENT SHALL MICROCHIP BE LIABLE FOR ANY DIRECT, INDIRECT, INCIDENTAL, SPECIAL, EXEMPLARY, OR CONSEQUENTIAL DAMAGES (INCLUDING BUT NOT LIMITED TO PROCUREMENT OF SUBSTITUTE GOODS OR SERVICES; LOSS OF USE, DATA OR PROFITS; OR BUSINESS INTERRUPTION) HOWEVER CAUSED AND ON ANY THEORY OF LIABILITY, WHETHER IN CONTRACT, STRICT LIABILITY, OR TORT (INCLUDING NEGLIGENCE OR OTHERWISE) ARISING IN ANY WAY OUT OF THE USE OF THIS SOFTWARE, EVEN IF ADVISED OF THE POSSIBILITY OF SUCH DAMAGE.

(c) Copyright 1999-2013 Microchip Technology, All rights reserved

Intended use

The Primo system is a combined pay-as-you-go spindle probe, tool setter and radio transmission interface. The system enables automated workpiece inspection, job set-up, broken tool detection, rapid tool measurement on multi-tasking machines and machining centres and transmits the outputs to the CNC machine controller.

Safety

Information to the user

This product is supplied with non-rechargeable lithium metal batteries. Refer to the battery manufacturer's literature for specific battery operating, safety and disposal guidelines.

- Do not attempt to recharge the batteries.
- Replace the batteries only with the specified type.
- Do not mix new and used batteries in the product.
- Do not mix different types or brands of batteries in the product.
- Ensure that all batteries are inserted with the correct polarity in accordance with the instructions in this manual and indicated on the product.
- Do not store the batteries in direct sunlight.
- Do not expose the batteries to water.
- Do not expose the batteries to heat or dispose of the batteries in a fire.
- Avoid forced discharge of the batteries.
- Do not short circuit the batteries.
- Do not disassemble, apply excessive pressure, pierce, deform or subject the batteries to impact.
- Do not swallow the batteries
- Keep the batteries out of the reach of children.
- If the batteries are swollen or damaged do not use them in the product and exercise caution when handling them.
- Dispose of waste batteries in accordance with your local environmental and safety laws.

Ensure that you comply with international and national battery transport regulations when transporting the batteries or this product with the batteries inserted. Lithium metal batteries are classified as dangerous goods for transportation and require labelling and packaging in accordance with the dangerous goods regulations before being offered for transportation. To reduce the risk of shipment delays, should you need to return this product to Renishaw for any reason, do not return any batteries.

Information to the machine supplier/ installer

It is the machine supplier's responsibility to ensure that the user is made aware of any hazards involved in operation, including those mentioned in Renishaw product literature, and to ensure that adequate guards and safety interlocks are provided.

Under certain circumstances, the probe signal may falsely indicate a probe seated condition. Do not rely on probe signals to halt the movement of the machine.

Information to the equipment installer

All Renishaw equipment is designed to comply with the relevant UK, EU and FCC regulatory requirements. It is the responsibility of the equipment installer to ensure that the following guidelines are adhered to, in order for the product to function in accordance with these regulations:

- Any interface MUST be installed in a position away from any potential sources of electrical noise (for example, power transformers, servo drives).
- All 0 V/ground connections should be connected to the machine “star point” (the “star point” is a single point return for all equipment ground and screen cables). This is very important and failure to adhere to this can cause a potential difference between grounds.
- All screens must be connected as outlined in the user instructions.
- Cables must not be routed alongside high current sources (for example, motor power supply cables), or be near high-speed data lines.
- Cable lengths should always be kept to a minimum.

Equipment operation

If this equipment is used in a manner not specified by the manufacturer, the protection provided by the equipment may be impaired.

Renishaw GoProbe cycles

Each Primo system is supplied with Renishaw GoProbe software and the Renishaw GoProbe training kit.

Renishaw GoProbe software is a unique ‘all-in-one’ probing solution that supports all the Renishaw GoProbe cycles. The GoProbe cycles use a single-line command to simplify the use of standard probing cycles.

GoProbe combines multiple GoProbe cycles for part setting, tool setting and probe set-up:

- 9901 – Part setting
- 9921 – Tool setting
- 9931 – System ready

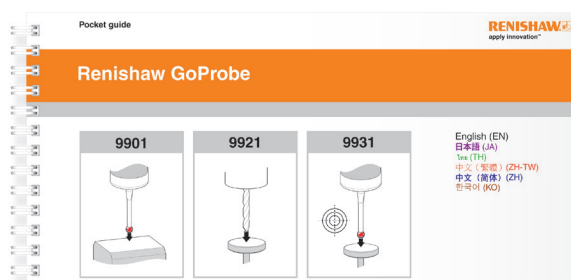

GoProbe provides:

- An easy and intuitive way to get started with setting cycles.
- A simple and consistent 'five step' method of operation.
- A choice of manual (jog) mode or automated mode.
- A solution that is compatible with a range of Renishaw probes as well as the Primo system.

GoProbe training kit

To ensure the maximum benefit from the Primo system, Renishaw provides each Primo customer with a GoProbe training kit: the training kit helps new users to get up and running with their new probing system quickly and easily.

The training kit centres on the GoProbe training part, which has been designed to incorporate the most common features encountered during automated setting and manufacturing. The GoProbe training part is used to demonstrate all the probing cycles and is used in the e-learning practical exercises.

The GoProbe e-learning course is a PC-based course that will guide both new and experienced users through the basics of probing using a combination of intuitive tutorials, interactive quizzes and practical exercises.

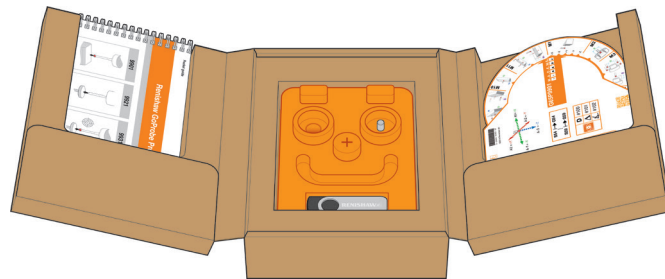

By completing this training the user will be able to check that the Primo system is ready for use, and will be able to use part setting, tool setting and probe set-up cycles with confidence.

Other learning aids included in the training kit are the pocket guide and quick-reference tool, for convenient continual use at the machine. A GoProbe smartphone app is also available – see www.renishaw.com/goprobe for details.

Each Primo system should be supplied with a training kit from your machine tool supplier. If you have not received the training kit or if any elements are missing, contact your local Renishaw office, which can be found by visiting www.renishaw.com/contact.

This page is intentionally left blank.

Primo™ radio part setter and Primo™ radio 3D tool setter basics

Introduction

When used within a Primo system:

- The Primo™ radio part setter enables part set-up and inspection on machining centres.
- The Primo™ radio tool setter enables tool setting and broken tool detection (length and diameter).

The part setter and tool setter deliver interference-tolerant radio transmission through the use of frequency-hopping spread spectrum (FHSS), allowing multiple systems to work in the same machine shop without interference. Using radio transmission enables operation without line-of-sight.

Getting started

The part setter and tool setter are fitted with LEDs to provide visual indication of their status as well as overall system status. For further information, see "Part setter and tool setter LED guide" on **page 5-18**, and "Interface LED signals" on **page 5-20**.

Credit

The Primo system requires credit to function. Credit comes in the form of a credit token. This is inserted into the part setter. For further information, see "Installing the credit token cassette" on **page 5-29** and "Changing the credit token" on **page 5-30**. The credit is then transferred to the interface. For further information, see "Credit transfer" on **page 5-32**.

Modes of operation

Standby mode: the interface is waiting for a switch-on signal from the machine tool before it can send a switch-on signal to the equipment.

Operational mode: this is activated by a switch-on signal from the interface or by spinning the spindle (part setter only). The equipment is ready for use.

Acquisition mode: this is used to partner the part setter and tool setter with the interface. For further information, see "Acquisition method" on **page 5-25**.

Credit transfer mode (part setter only): this is used to transfer credit from the credit token via the part setter to the interface. For further information, see "Credit transfer" on **page 5-32**.

Configurable settings

These settings can be configured by changing the DIP switches on the interface. For further information, see "Switch SW1 output configuration" and "Switch SW2 output configuration" on **page 3-5**.

Function		Description	Factory setting
Part setter switch-on/ switch-off method	Radio on/radio off	Commanded by machine output. Turn-on time is 1 second maximum.	Radio on/radio off
	Spin on/spin off	Spin at 1000 r/min for 1.5 seconds minimum.	
Enhanced trigger filter		The enhanced trigger filter improves the equipment's resistance to false triggers caused by rapid traversing or excessive vibration.	OFF
Hibernation mode		When the part setter or tool setter is in standby mode and the interface is powered off or out of range, the equipment enters hibernation (low power) mode after a timeout. The part setter or tool setter 'wakes' from hibernation periodically to check for their partnered interface. The 'wake' signal is sent every 30 seconds when hibernation is enabled.	ENABLED

Tool setter switch-on/switch-off

The switch-on/switch-off method for the tool setter is not user-configurable. The method used is radio on/radio off.

Enhanced trigger filter

When the filter is enabled, an additional 10 ms filter delay is introduced to the equipment output.

It may be necessary to reduce the part setter's approach speed to allow for the increased stylus overtravel during the extended time delay.

Recalibration

If settings are changed via the interface DIP switches, it is vital that the equipment is recalibrated (see "Calibrating the Primo equipment" on **page 5-16**, for further information).

Acquisition mode

The partnering of the part setter or tool setter with the interface is described on **page 5-25**, "Acquisition method".

NOTE: To place the interface in acquisition mode, turn the interface off, then on again.

Partnering is required during initial Primo system set-up or if the part setter switch-on method is changed.

Partnering will not be lost by reconfiguration of the equipment settings or when changing the batteries.

Partnering can take place anywhere within the performance envelope. For more information, see "Performance envelopes" on **page 5-2**.

Primo credit token

NOTE: The Primo system will not work without credit being available in the system.

The standard credit token contains 6 months' worth of credit. For more information, see "Installing the credit token cassette" on **page 5-29**.

Primo upgrade credit token

An upgrade credit token enables the Primo system to work for an unlimited period.

Credit transfer



Credit is loaded into the Primo system by transferring credit from the credit token into the interface. For more information, see "Credit transfer" on **page 5-32**.

How to purchase a credit token

You can purchase 6-month credit tokens and upgrade credit tokens from the Primo website: **www.renishaw.com/primo**.

You can also contact your local Renishaw supplier (see **www.renishaw.com/contact**).

Low credit indicators

When any of these low credit indicators are shown, it is recommended that a new credit token is loaded into the system.

1. Equipment LEDs flash yellow.



Slow flash	Maximum 21 days' credit remaining
Fast flash	Maximum 10 days' credit remaining

2. Interface low credit/low battery LED is illuminated (indicates low credit [maximum 21 days] or low battery).

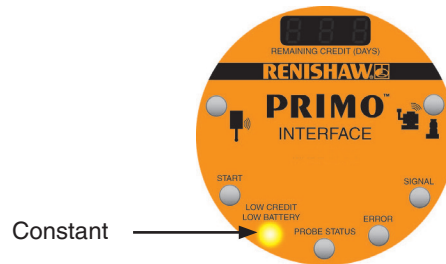

3. Interface digital display (indicates the number of days of credit remaining). When the remaining credit display reads 0 days, the Primo system will stop working and new credit must be loaded into the system to continue operation.

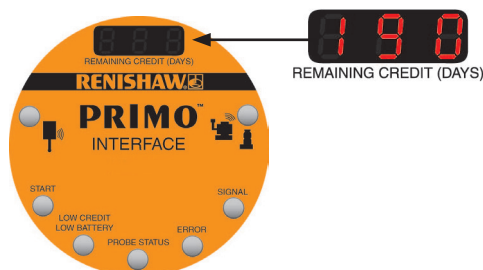

4. Low credit/low battery solid-state relay (SSR) output from the interface, which can be connected to the machine controller. When credit is running low, the SSR changes state. The SSR can be configured normally open or normally closed. For further information, see "Switch SW1 output configuration" and "Switch SW2 output configuration" on **page 3-5**.

Part setter operation

The part setter operates as a highly accurate and repeatable mechanical switch that triggers as the stylus deflects against a surface.

- The part setter can trigger in the X, Y and Z axes.
- The part setter can be used for work co-ordinate setting and for workpiece measurement.
- A trigger signal is sent directly to the CNC controller so that offsets can be updated – no manual intervention is required.



Tool setter operation

The tool setter enables accurate machining by measuring the length and diameter of tools using the same highly accurate and repeatable switch mechanism as the part setter.

- The tool is set in the Z axis for tool length measurement and broken tool detection.
- Rotating tools are set in the X and Y axes for tool radius measurement.

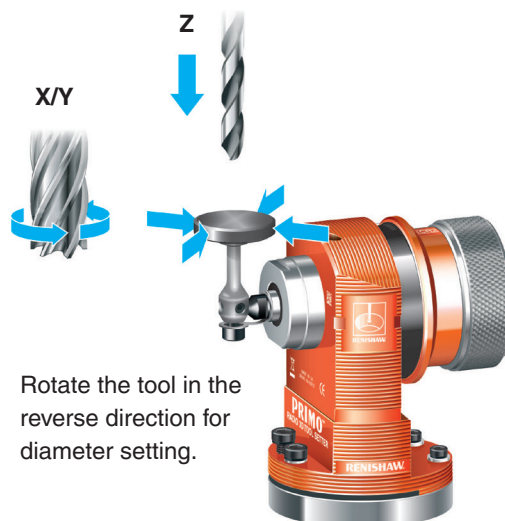

Software routines

GoProbe software caters for 3-axis applications and covers basic probing routines:

- Workpiece set-up
- Workpiece measurement
- Tool setting
- Broken tool detection
- Calibration

For further information, see the GoProbe programming manual relevant to your controller, available at www.renishaw.com/primo.

Primo™ interface basics

Introduction

The interface enables communication between the machine tool, part setter and tool setter using radio frequency transmission.

Power supply

The Primo interface can draw its supply from the CNC machine tool's 12 Vdc to 30 Vdc supply and present a peak load of up to 500 mA during turn on (typically < 100 mA from 12 V to 30 V).

WARNING: The Primo system has been designed to work over the specified supply voltage range and should be powered with a suitable protected extra low voltage supply (PELV). Renishaw cannot guarantee user safety if the Primo system is operated outside of these requirements.

NOTE: If the Primo system is using an upgrade credit token and the interface is returned to Renishaw, the upgrade credit token must be returned with the interface for identification purposes.



Interface visual diagnostics

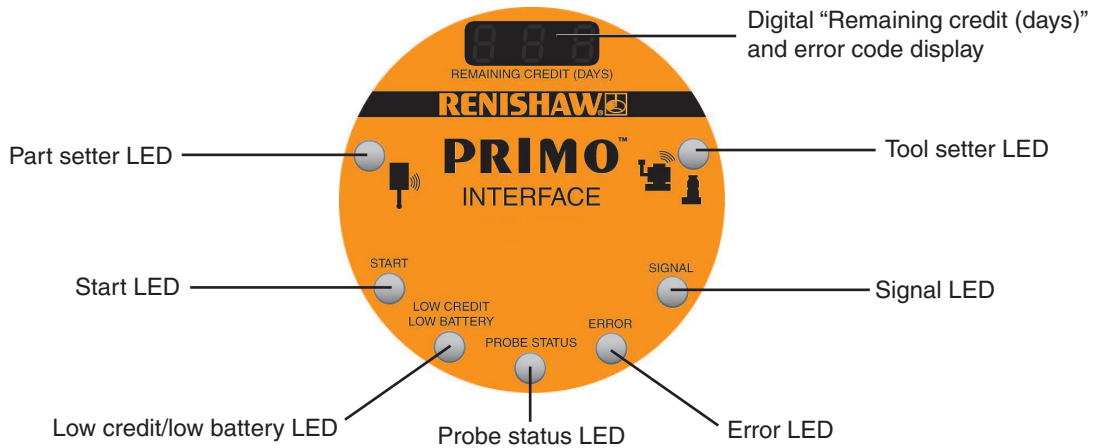

Interface inputs

Machine start inputs

'Machine start' is configurable as a level or pulsed signal.

SW2-3 set to level	P1	Active *	Part setter is switched on.
	P2	Active *	Tool setter is switched on.
SW2-3 set is pulsed	P1	Pulsed to alternatively switch on and off the selected probe	
	P2	Active *	Tool setter is selected.
	P2	OFF	Part setter is selected.

* Active = +12 Vdc to +30 Vdc with respect to the machine start common

For the full interface switch settings, see "Switch SW1 output configuration" and "Switch SW2 output configuration" on **page 3-5**. For the full interface wiring diagram, see "Interface wiring diagram" on **page 5-13**.

Interface outputs

There are four SSR outputs:

- Probe status 1
- Probe status 2
- Error
- Low credit/low battery

All outputs can be inverted by using the interface DIP switches SW1 and SW2. For further information, see "Switch SW1 output configuration" and "Switch SW2 output configuration" on **page 3-5**).

NOTE: The term '**Probe status**' refers to the measurement hardware in the system interacting with the interface and can therefore refer to the part setter or the tool setter.

SSR outputs specifications

- Maximum 'on' resistance = 25 Ω
- Maximum load voltage = 30 V
- Maximum load current = 100 mA

Interface output waveform

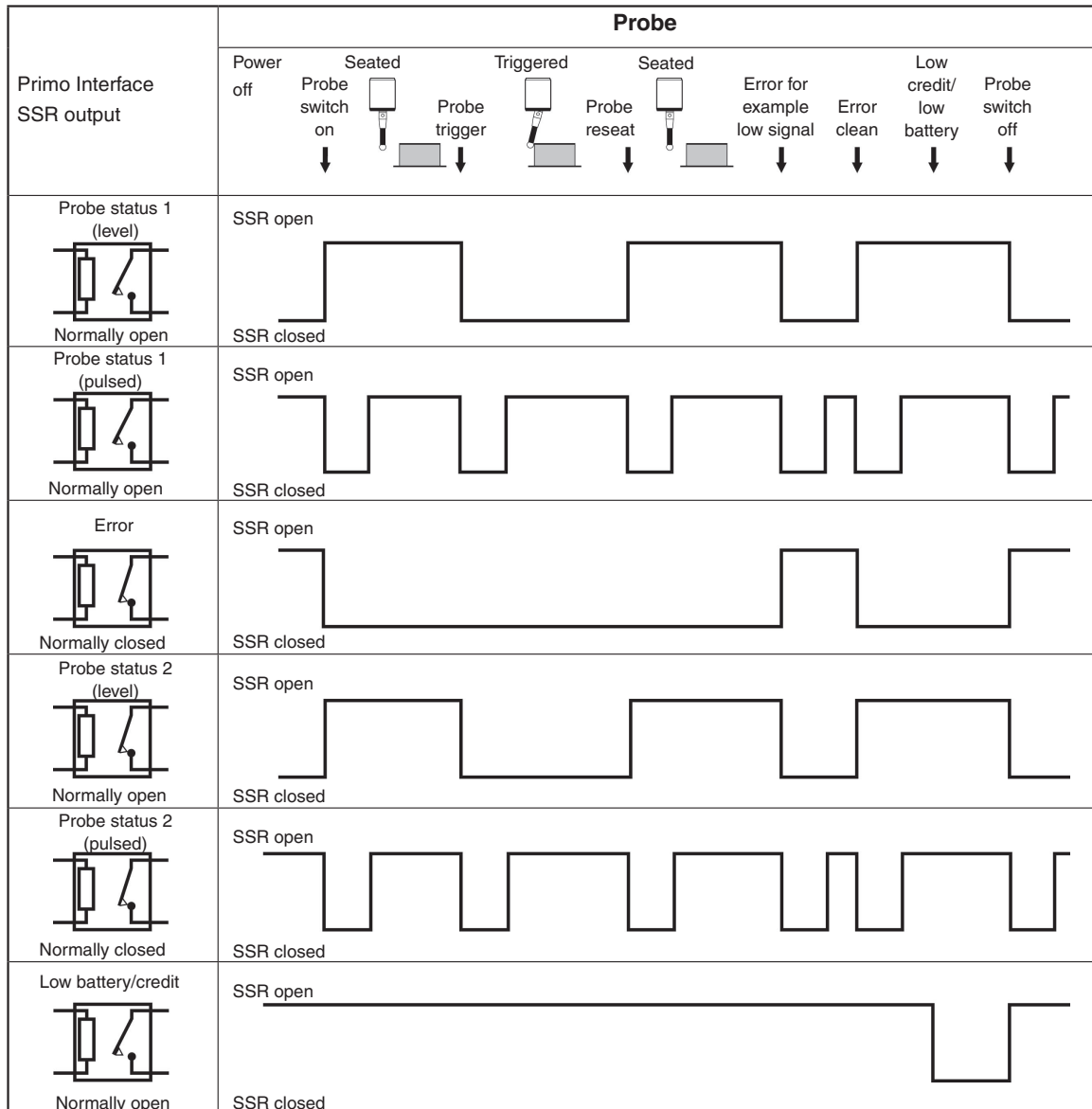

Signal delays:

1. **Transmission delay:** probe trigger to output change of state = 10 ms ±10 μs without enhanced trigger filter
2. **Start delay:** time from initiation of start signal to valid signal transmission = 1 second maximum for radio on/radio off (or 1.5 seconds for spin on/spin off).

Switches SW1 and SW2

NOTE: To gain access to the switches, remove the front cover (see "Removing the interface cover" on page 6-5, for further information).

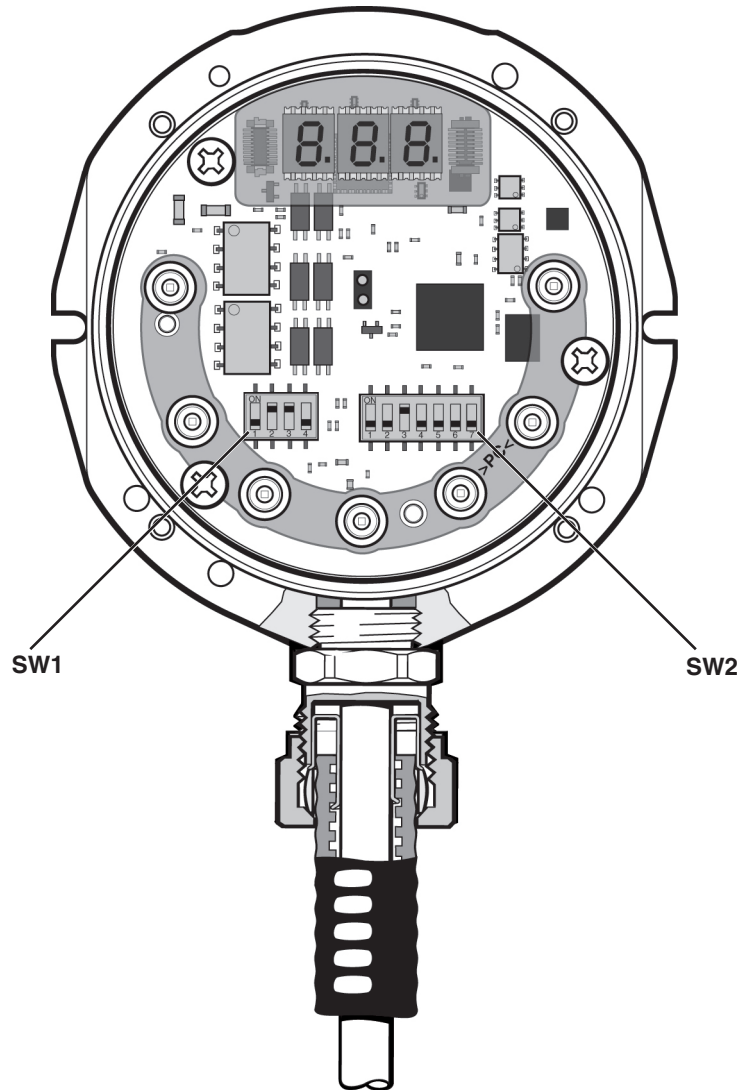

Switch SW1 output configuration

NOTE: If the error code **E08** appears on the Primo interface “Remaining credit (days)” digital display when a DIP switch setting has been changed, the part setter must be reacquired or the DIP switch returned to its original position.

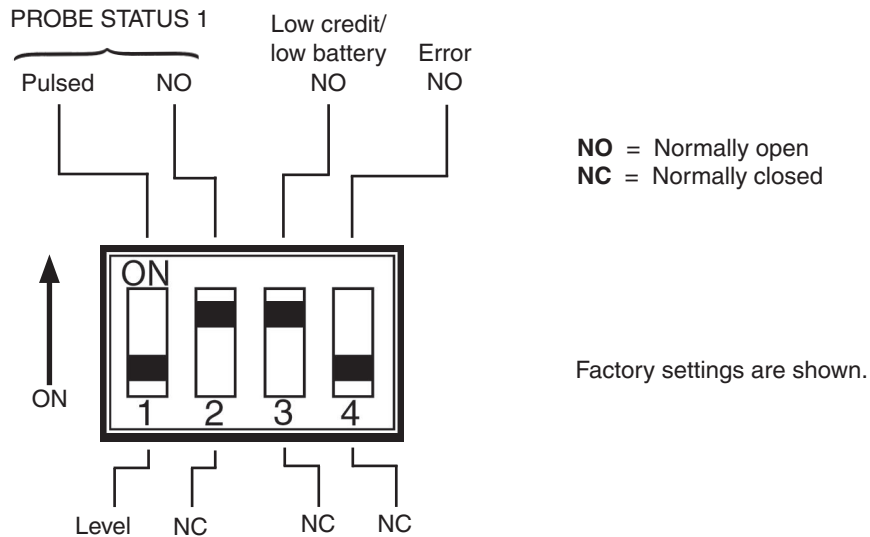

CAUTION: When using error or probe SSR in NO mode, a wiring fault could cause loss of error condition, and could therefore result in a non-failsafe condition.

Switch SW2 output configuration

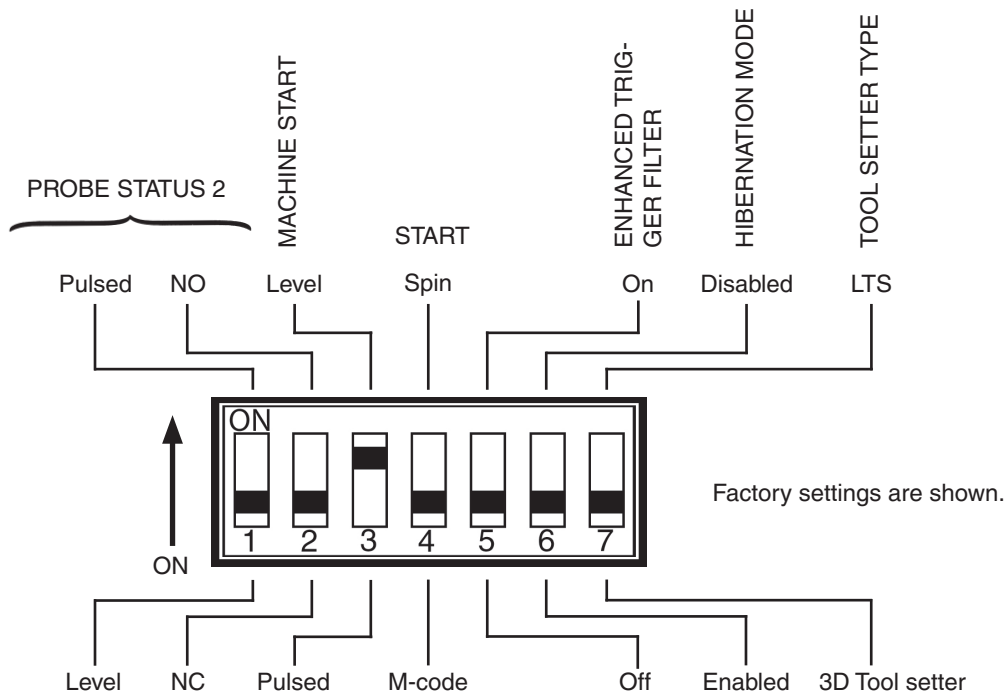

This page is intentionally left blank.

Dimensions and specifications

Part setter dimensions

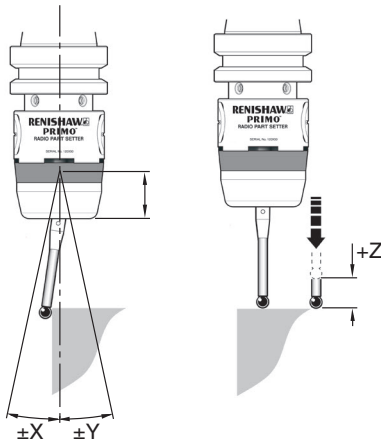
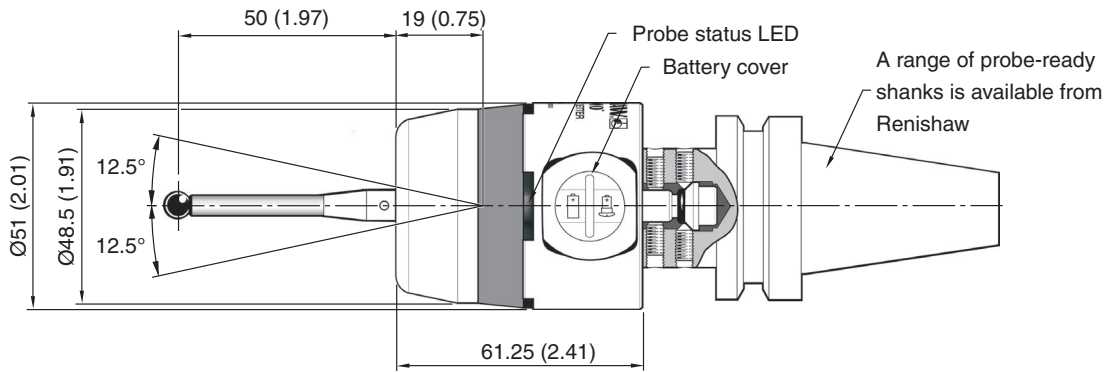

Stylus overtravel limits		
Stylus length	$\pm X / \pm Y$	$+Z$
50 (1.97)	12 (0.47)	6 (0.24)
100 (3.94)	22 (0.87)	6 (0.24)

Dimensions given in mm (in)

Tool setter dimensions

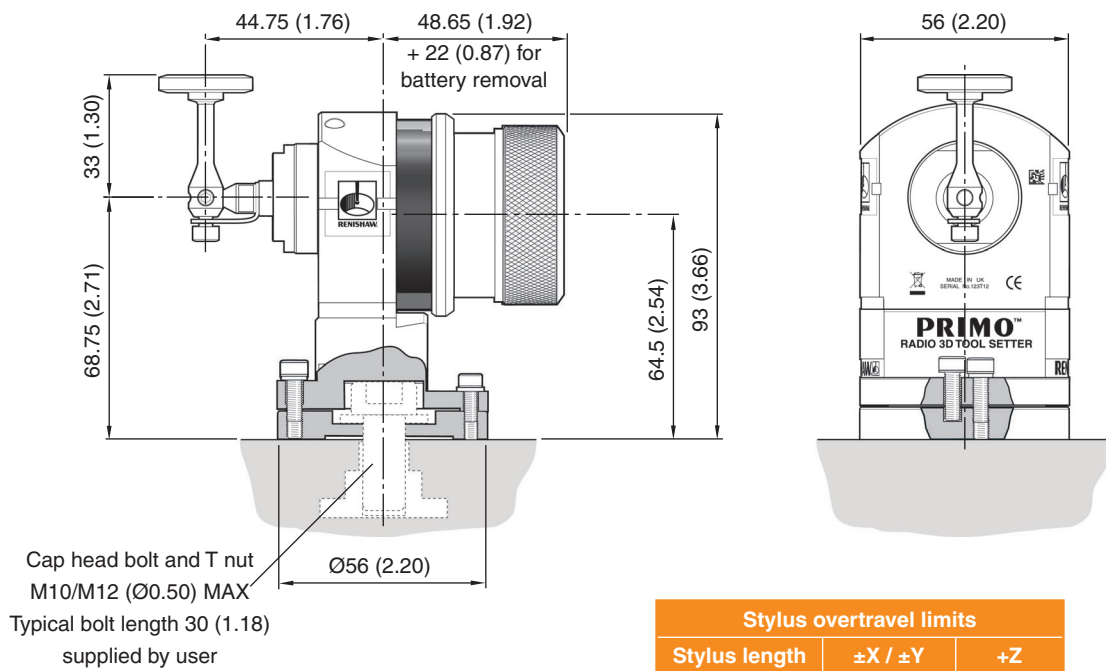

Dimensions given in mm (in)

Disc stylus Ø26 mm × 4 mm

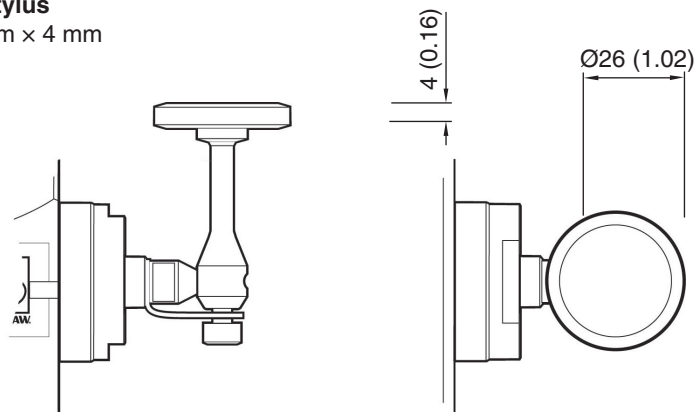

Dimensions given in mm (in)

Interface dimensions

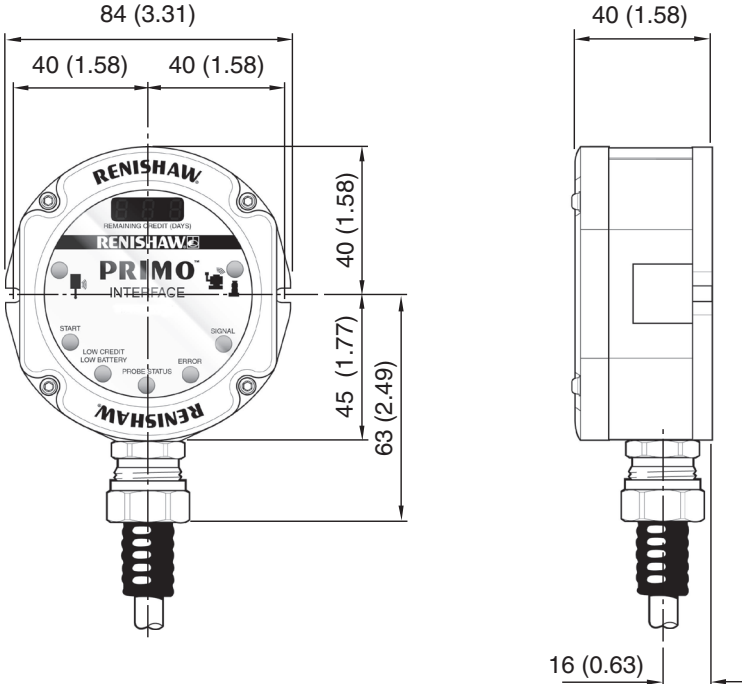

Dimensions given in mm (in)

Part setter specification

Principal application	Used for workpiece set-up and inspection.	
Dimensions	Length	61.25 mm (2.41 in)
	Diameter	51 mm (2.01 in)
Weight without shank (including battery and credit token)	350 g (12.35 oz)	
Transmission type	Frequency-hopping spread spectrum (FHSS) radio.	
Radio frequency	2400 MHz to 2483.5 MHz	
Operating range	Up to 10 m (32.8 ft)	
Receiver/interface	Primo™ interface	
Recommended stylus	M4 stylus with 50 mm (1.97 in) ceramic stem and 6 mm (0.24 in) ruby ball.	
Switch-on / switch-off options	Radio on → Radio off	Spin on → Spin off
Spindle speed (maximum)	1000 r/min	
Sense directions	±X, ±Y, +Z	
Unidirectional repeatability	1.00 μm (40 μin) 2σ ¹	
Stylus trigger force^{2 3} Factory setting: XY low force XY high force +Z	0.50 N, 51 gf (1.80 ozf) 0.90 N, 92 gf (3.24 ozf) 5.85 N, 597 gf (21.04 ozf)	
Mounting	Taper shank in machine tool spindle.	
Environment	IP rating	IPX8, BS EN 60529:1992+A2:2013
	Storage temperature	-25 °C to +70 °C (-13 °F to +158 °F)
	Operating temperature	+5 °C to +55 °C (+41 °F to +131 °F)
Battery types	1 × ½ AA (3.6 V) lithium-thionyl chloride	1 × CR2 (3 V) lithium-manganese dioxide
Battery life	See table below.	
Low battery indication	Flashing blue LED while the part setter is seated (not triggered).	
Dead battery indication	Continuous red LED.	
Low credit indication	Flashing yellow LED while the part setter is seated (not triggered).	
No credit indication	Continuous yellow LED.	

- 1 Performance specification is tested at a standard test velocity of 480 mm/min (18.9 in/min) with a 50 mm (1.97 in) stylus. Significantly higher velocity is possible depending on application requirements.
- 2 Trigger force, which is critical in some applications, is the force exerted on the component by the stylus when the probe triggers. The maximum force applied will occur after the trigger point (for example overtravel). The force value depends on related variables including measuring speed, machine deceleration and latency.
- 3 These are the factory settings; manual adjustment is not possible.

Typical battery life

Battery type	Standby life	5% usage (72 minutes/day)	Continuous use
CR2 lithium manganese dioxide	270 days	75 days	155 hours
½ AA lithium-thionyl chloride	410 days	125 days	260 hours

Tool setter specification

Principal application	Tool measurement and broken tool detection on small to medium CNC machining centres.	
Dimensions	Length	93.40 mm (3.68 in)
	Width	56 mm (2.20 in)
	Height	101.75 mm (4.01 in)
Weight with disc stylus (including battery)	660 g (23.28 oz)	
Transmission type	Frequency-hopping spread spectrum (FHSS) radio	
Radio frequency	2400 MHz to 2483.5 MHz	
Operating range	Up to 10 m (32.8 ft)	
Receiver/interface	Primo™ interface	
Recommended stylus	26 mm (1.02 in) diameter disc stylus, tungsten carbide	
Switch-on / switch-off options	Radio on → Radio off	
Sense directions	±X, ±Y, +Z	
Unidirectional repeatability	1.00 µm (40 µin) 2σ ¹	
Stylus trigger force^{2 3}	1.30 N to 2.40 N, 133 gf to 245 gf (4.68 ozf to 8.63 ozf) depending on sense direction.	
Mounting	The tool setter is mounted on the machine table using a cap head bolt and T nut (not supplied by Renishaw).	
Environment	IP rating	IPX8, BS EN 60529:1992+A2:2013
	Storage temperature	-25 °C to +70 °C (-13 °F to +158 °F)
	Operating temperature	+5 °C to +55 °C (+41 °F to +131 °F)
Battery types	1 × ½ AA (3.6 V) lithium-thionyl chloride	1 × CR2 (3 V) lithium-manganese dioxide
Battery life	See table below.	
Low battery indication	Flashing blue LED while the part setter is seated (not triggered).	
Dead battery indication	Continuous red LED.	
Low credit indication	Flashing yellow LED while the part setter is seated (not triggered).	
No credit indication	Continuous yellow LED.	

- 1 Performance specification is tested at a standard test velocity of 480 mm/min (18.9 in/min) with a 50 mm (1.97 in) stylus. Significantly higher velocity is possible depending on application requirements.
- 2 Trigger force, which is critical in some applications, is the force exerted on the component by the stylus when the probe triggers. The maximum force applied will occur after the trigger point (for example overtravel). The force value depends on related variables including measuring speed, machine deceleration and latency.
- 3 These are the factory settings; manual adjustment is not possible.

Typical battery life

Battery type	Standby life	5% usage (72 minutes/day)	Continuous use
CR2 lithium manganese dioxide	270 days	75 days	155 hours
½ AA lithium-thionyl chloride	410 days	125 days	260 hours

Interface specification

Principal application	Used to communicate signals between the part setter or tool setter and the CNC machining centre.	
Dimensions	Height	103 mm (4.05 in)
	Width	84 mm (3.31 in)
	Depth	40 mm (1.57 in)
Weight (with 8 m (26.2 ft) cable)	950 g (33.51 oz)	
Transmission type	Frequency-hopping spread spectrum (FHSS) radio	
Radio frequency	2400 MHz to 2483.5 MHz	
Operating range	Up to 10 m (32.8 ft)	
Compatible probes	Primo™ radio part setter, Primo™ radio 3D tool setter and LTS	
Supply voltage	12 Vdc to 30 Vdc	
Supply current	100 mA at 24 V peak, 30 mA typical	
Output signal	Four machine outputs, comprising four solid-state relays (SSR) configurable normally open or normally closed to be used for probe status 1, 2, error and low battery / low credit; all of which can be inverted.	
Input/output specification	SSR output is protected by a circuit which limits the current to 100 mA. M-code input: up to 30 V (10 mA at 24 V maximum) for part setter and tool setter. Power supply should be fused separately within the machine cabinet.	
Diagnostic LEDs	Digital 'credit days remaining' and error codes display, part setter, start, low credit / low battery, probe status, error, signal, tool setter / length tool setter.	
Cable	Specification	Ø7.5 mm (0.29 in), 15-core screened cable, each core 18 × 0.1 mm
	Length	8 m (26.2 ft)
Mounting	Directional mounting with optional mounting bracket or flush mounting (both available separately).	
Conduit	A flexible conduit to aid protection of the interface cable can be purchased as an optional extra. See page 5.14 , "Interface cable", for further information.	
Environment	IP rating	IPX8, BS EN 60529:1992+A2:2013
	Storage temperature	–25 °C to +70 °C (–13 °F to +158 °F)
	Operating temperature	+5 °C to +55 °C (+41 °F to +131 °F)

System installation

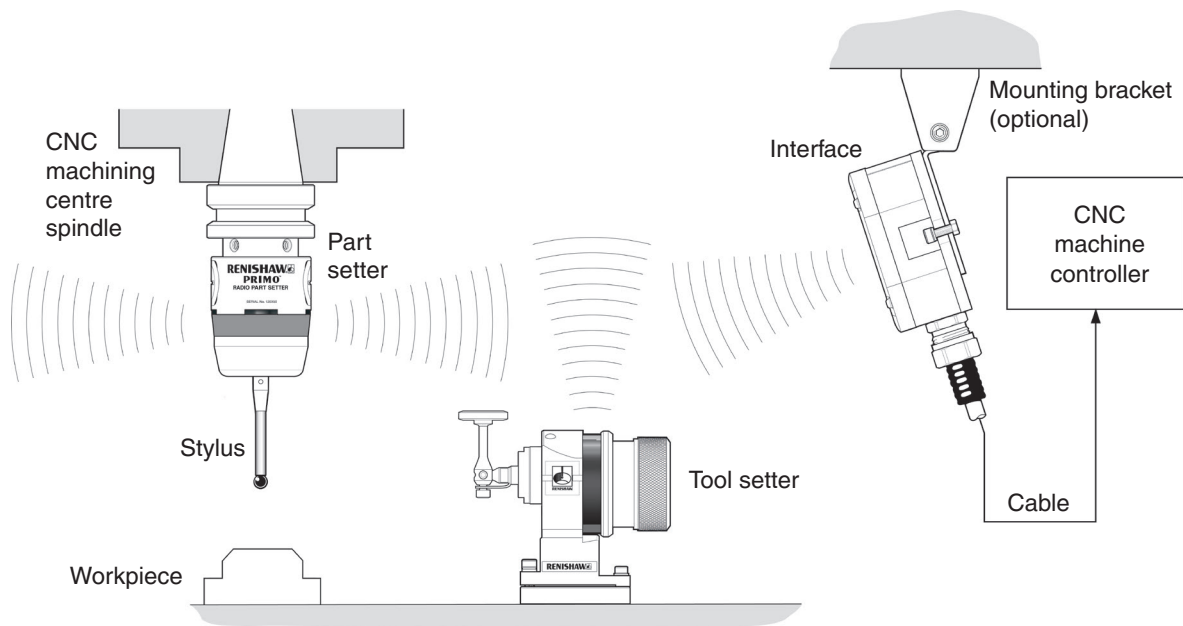

Operating envelope

Radio transmission does not require line-of-sight and will pass through small gaps and machine tool windows, providing a reflected path (of less than 10 m [32.8 ft]) is available.

Signal LED

The signal LED on the interface turns gradually from green to yellow as the environment causes signal degradation. When communication fails, the LED turns off.

The Primo system will continue to perform 100% effectively as long as there is signal.

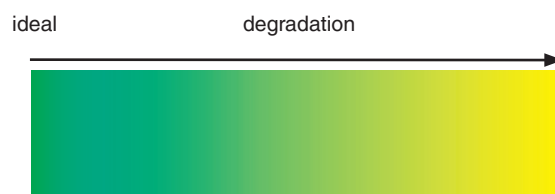

To ensure unrestricted transmission performance:

- Keep all Primo system components within the performance envelope. For further information, see "Performance envelopes" on **page 5-2**.
- A green signal LED represents an excellent signal, whereas yellow represents a reduced signal and is an indication to check radio communications. For further information, see "Part setter and tool setter LED guide" on **page 5-18**.

- Do not allow coolant or swarf residue to accumulate on the equipment.
- Regularly wipe clean the part setter body and the tool setter body.
- Reduction in transmission range may result when operating in temperatures outside the range of +5 °C to +55 °C (+41 °F to +131 °F).

Performance envelopes

Equipment positioning

The system elements should be positioned so that:

- The optimum range can be achieved over the full travel of the machine's axes.
- The front cover of the interface is facing in the general direction of the machining area.

Performance envelope for part setter

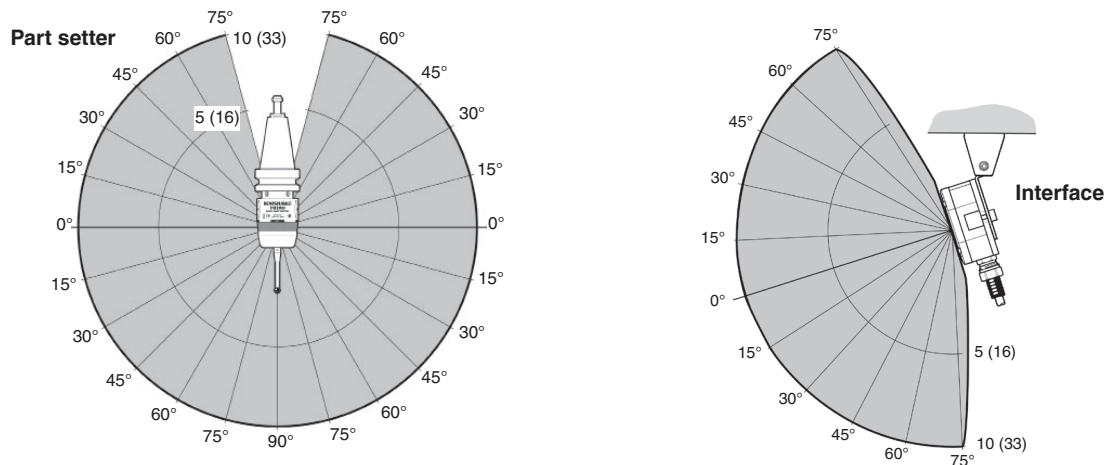

Typical plot at +20 °C (+68 °F)
Transmission range in m (ft)

■ Operating and switch-on / switch-off

Performance envelope for tool setter

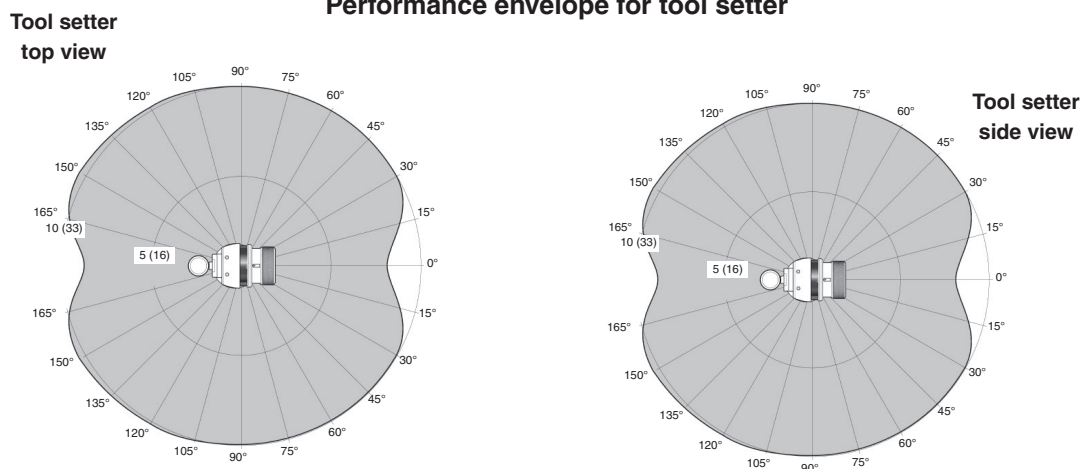

Typical plot at +20 °C (+68 °F)
Transmission range in m (ft)

■ Operating and switch-on / switch-off

Preparing the part setter

Fitting the stylus

To obtain the most accurate results from your part setter, it is recommended that you fit a Renishaw manufactured stylus.

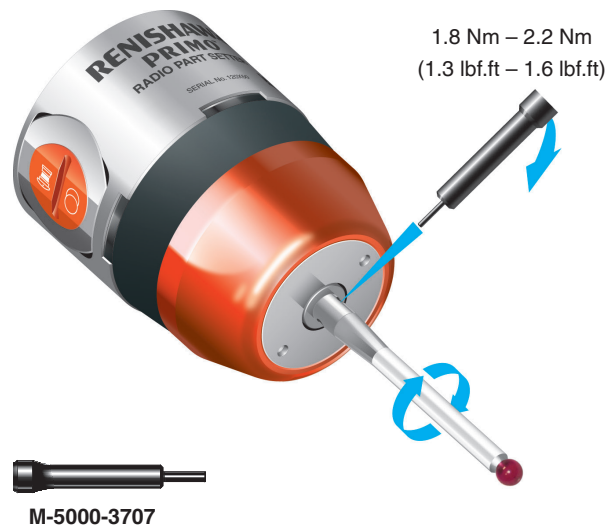
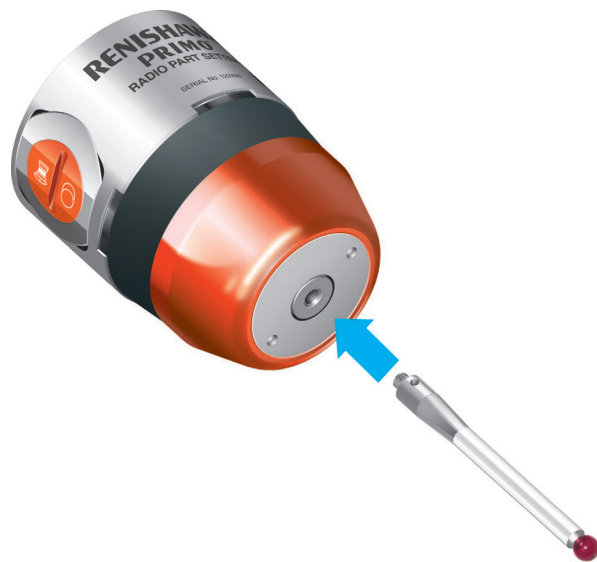

Installing the battery

NOTES:

See "Maintenance" on **page 6-1** for a list of suitable battery types.

Ensure the product is clean and dry before inserting batteries.

Do not allow coolant or debris to enter the battery compartment.

When inserting batteries, check that the battery polarity is correct.

For further information, see "Safety" on **page 1-3**.

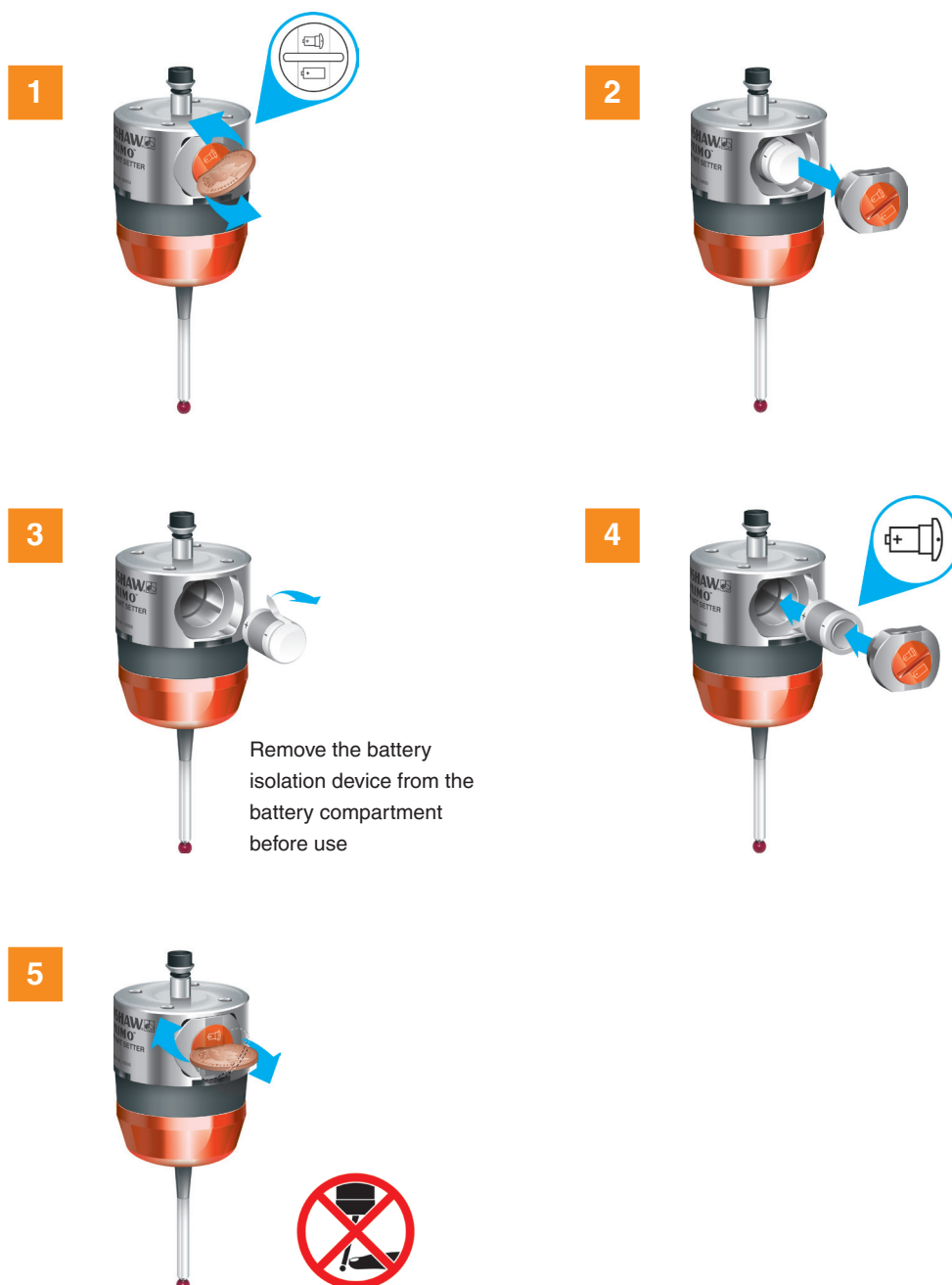

Mounting the part setter on a shank

1

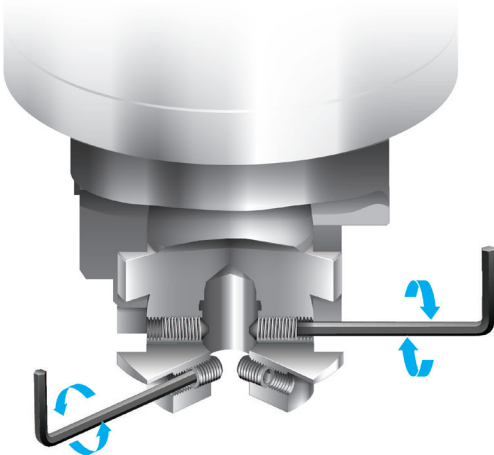

2

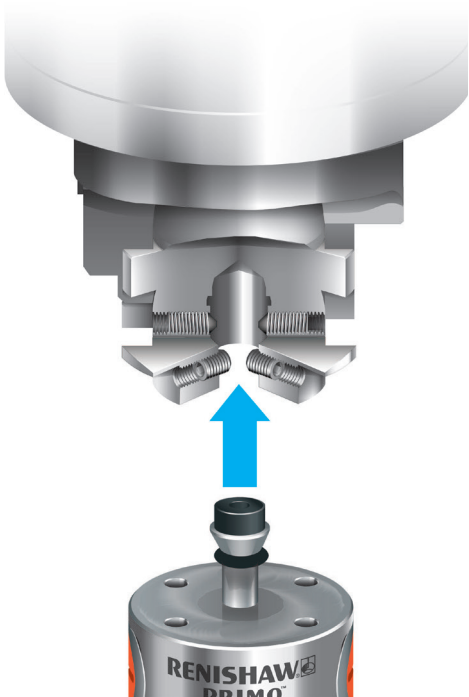

2



2 mm A/F
0.5 Nm – 1.5 Nm
(0.37 lbf.ft – 1.1 lbf.ft)
(x 2)

Part setter stylus on-centre adjustment

NOTES: If a part setter and shank assembly is dropped, it must be rechecked for correct on-centre adjustment. Do not hit the part setter to achieve on-centre adjustment.

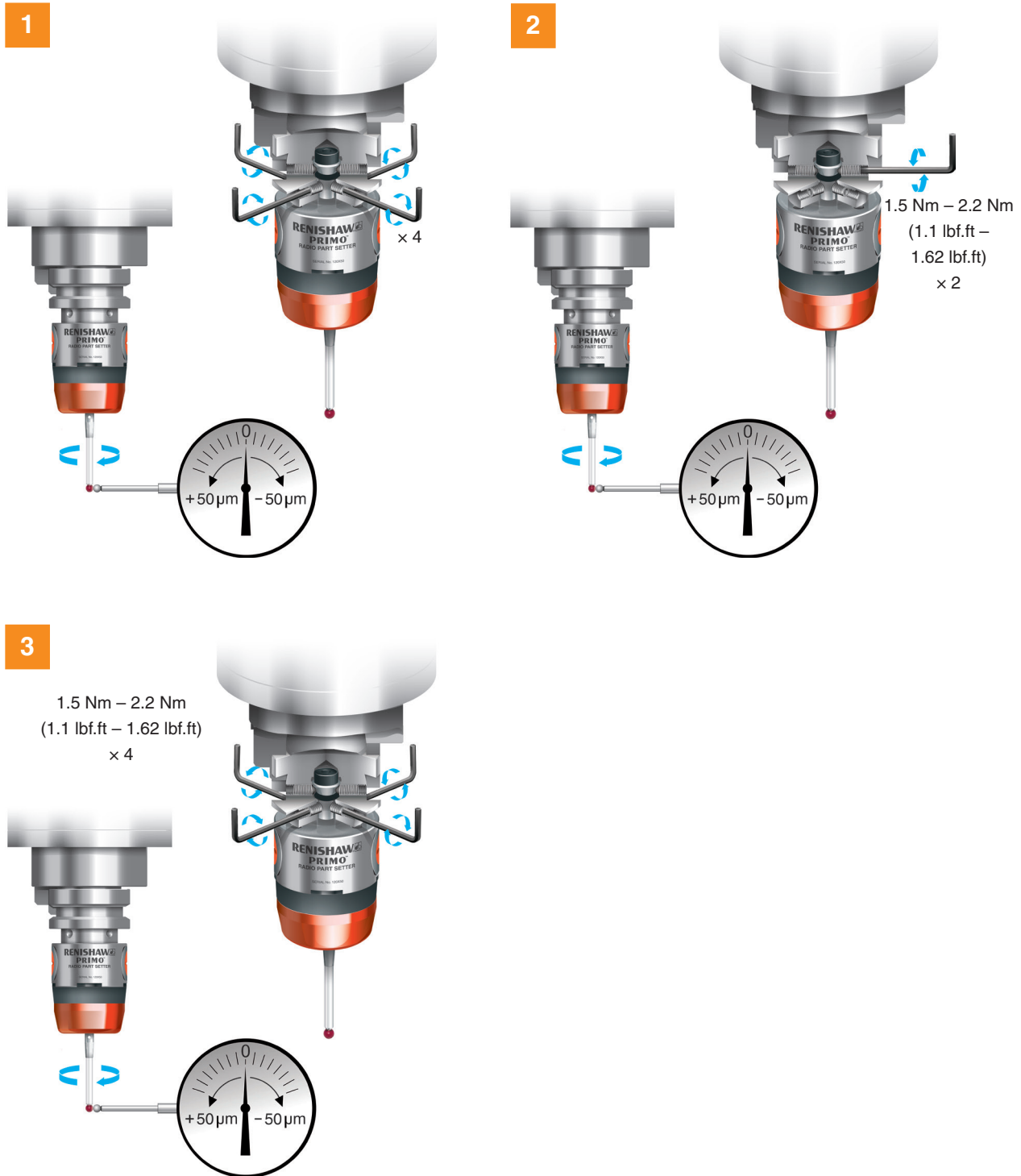

Preparing the tool setter for use

Fitting the stylus, break stem and captive link

Stylus weak link break stem

Incorporated into the stylus, the break stem protects the mechanism from damage in the event of excessive stylus overtravel or a collision. There is a compartment within the battery housing of the tool setter for a spare break stem to be stored.

Captive link

In the event of the break stem being damaged, the captive link ties the stylus to the probe.

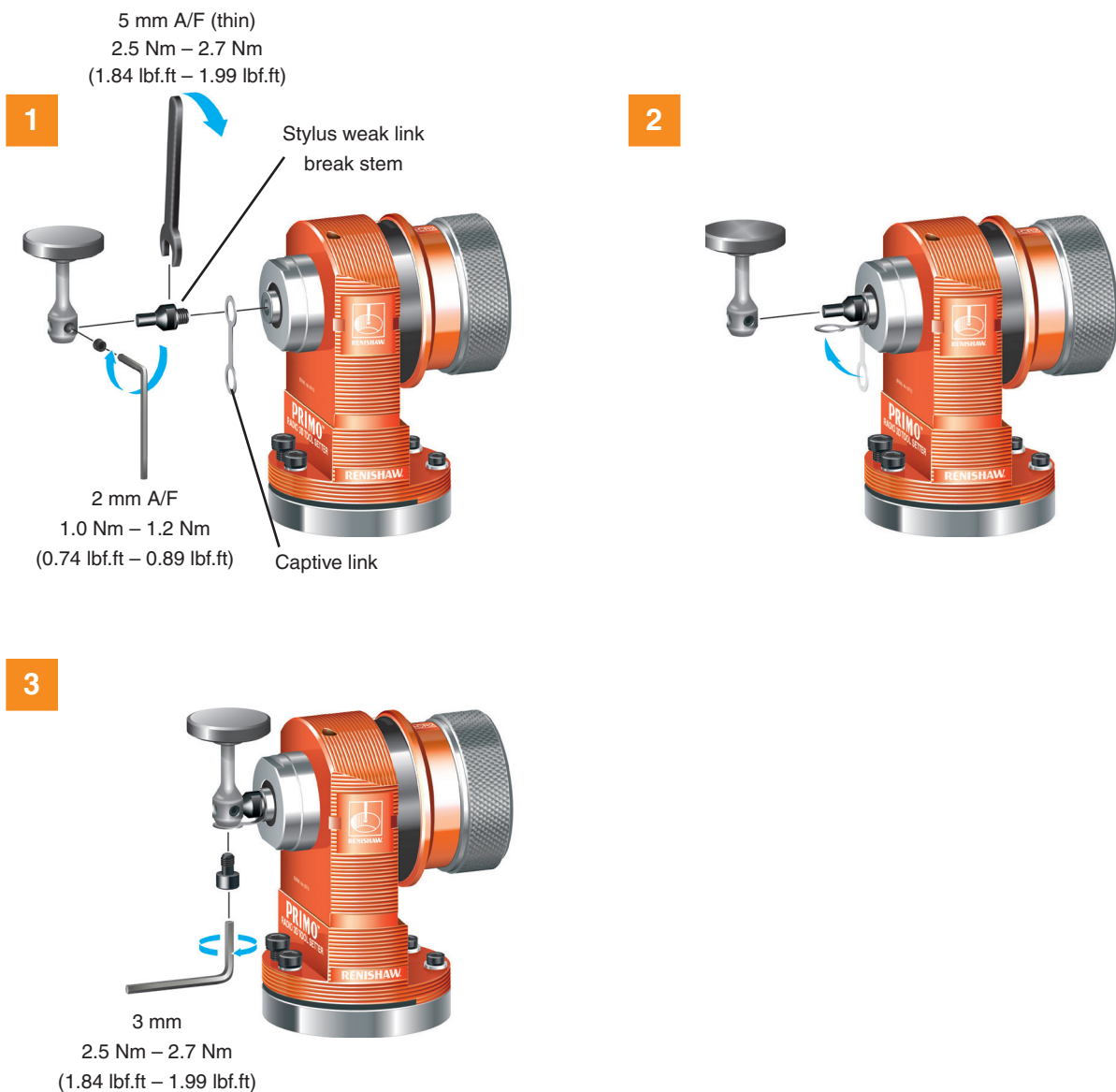

Installing the battery

NOTES:

See "Maintenance" on **page 6-1** for a list of suitable battery types.

Ensure the product is clean and dry before inserting batteries.

Do not allow coolant or debris to enter the battery compartment.

When inserting batteries, check that the battery polarity is correct.

For further information, see "Safety" on **page 1-3**.

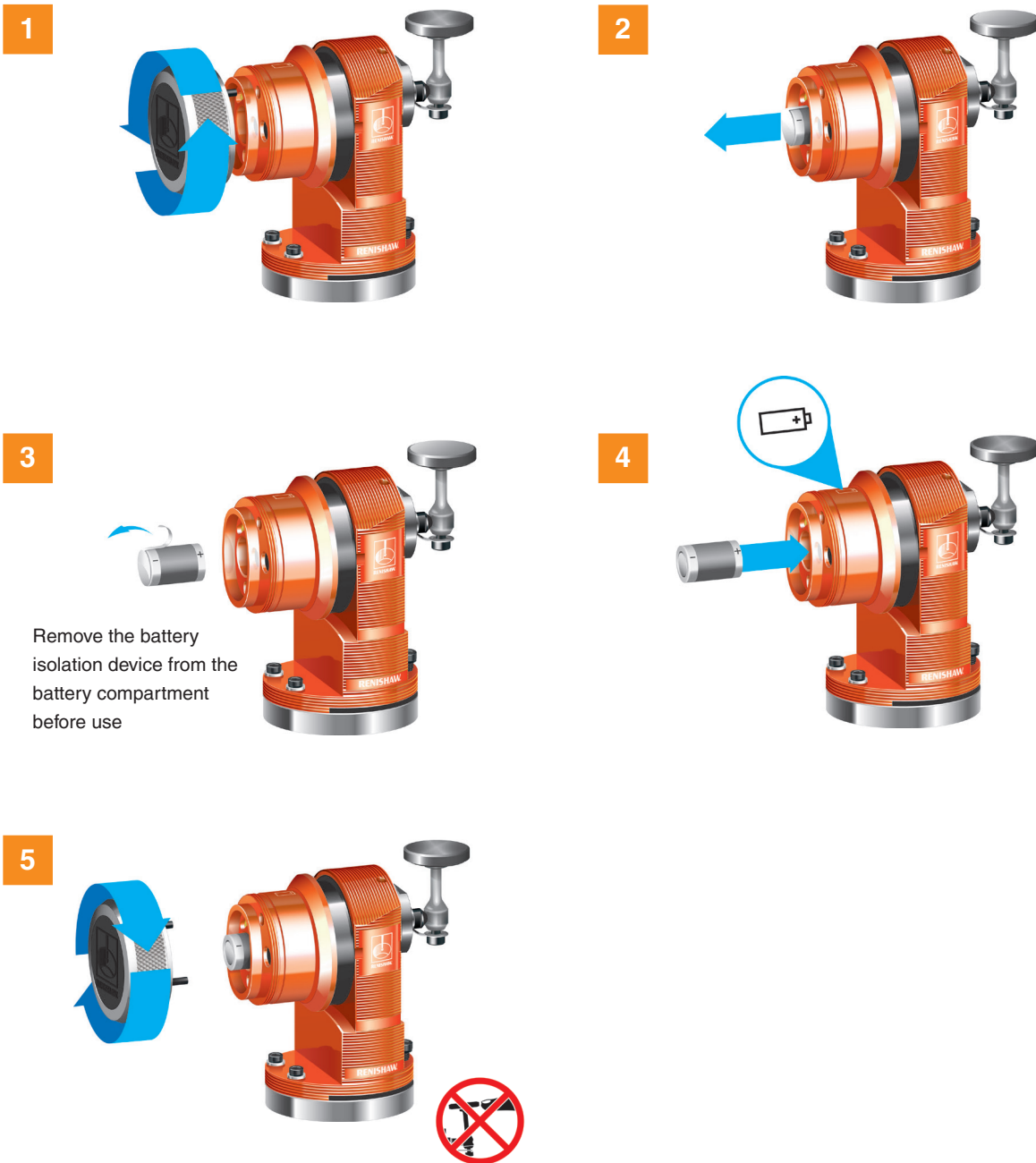

Mounting the tool setter on a machine table

1. Undo three of the four screws that hold the tool setter to the base.
2. Bolt the tool setter base to the table using an M12 or M10 cap head screw and washer (not supplied).
3. Reattach the tool setter to the base.

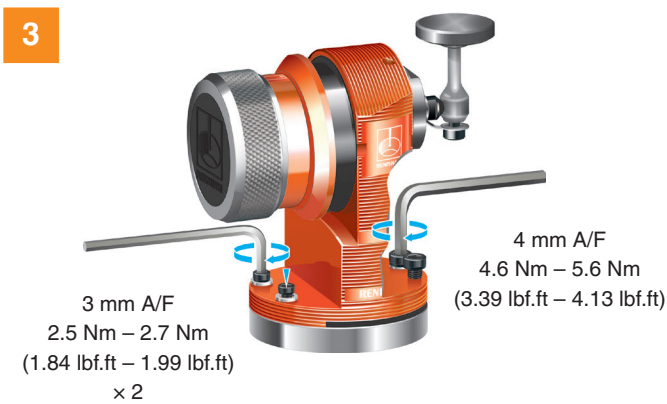

Tool setter stylus level setting

The top surface of the stylus must be set level.

Front-to-back level adjustment

NOTE: It is strongly recommended that you make this adjustment first.

To raise the front:

Slacken screw 2 and adjust the height with screw 1 until the stylus is level. To lock the position, fully tighten screw 2.

To lower the front:

Slacken screw 1 and adjust screw 2 until the stylus is level. To lock the position, fully tighten screw 1.

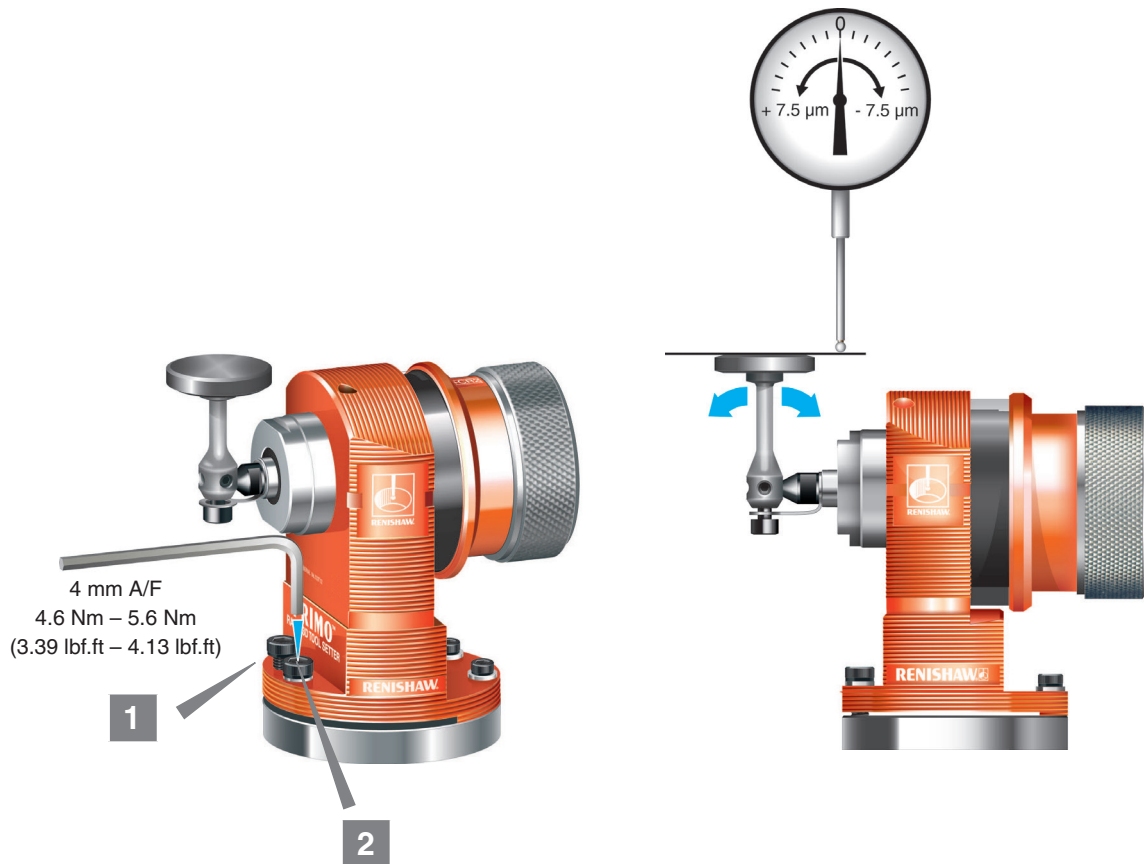

Side-to-side level adjustment

Alternately adjust the grub screws. This causes the tool setter to rotate and change the stylus level setting.

When the stylus surface is level, tighten the grub screws.

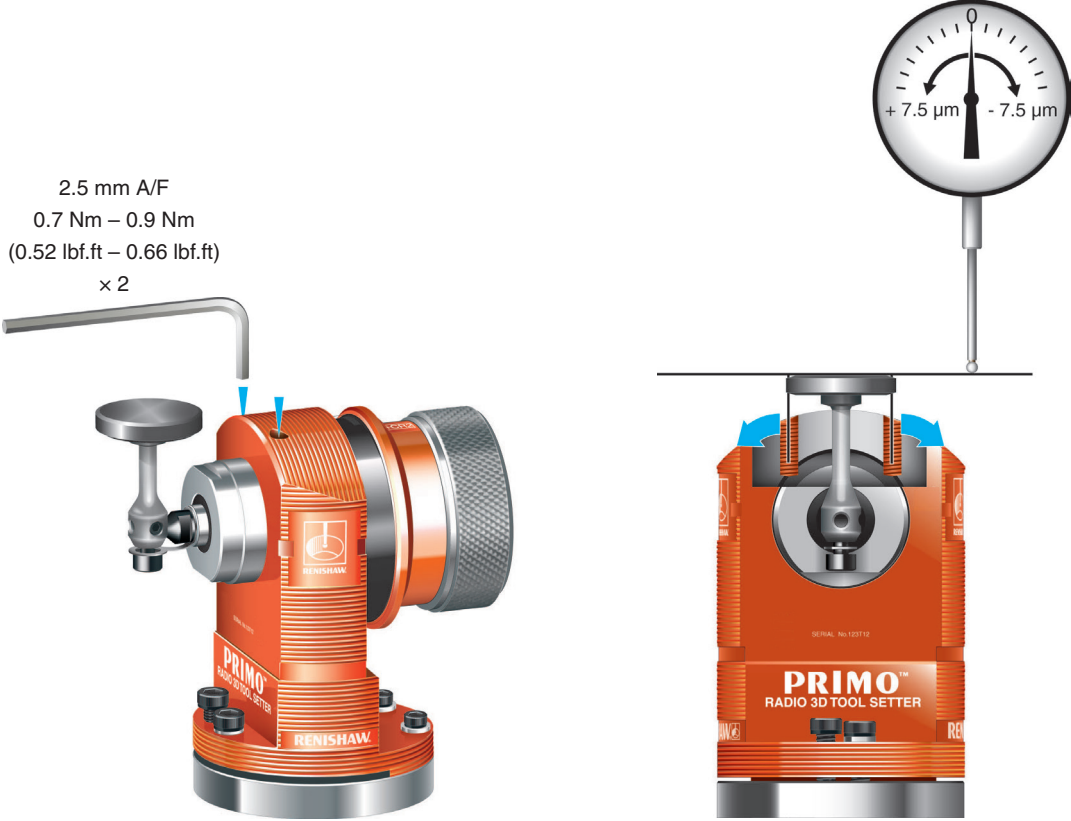

Preparing the interface for use

Mounting bracket (optional)

NOTE: Install the interface with the cable exiting from the lower side for good coolant run-off.

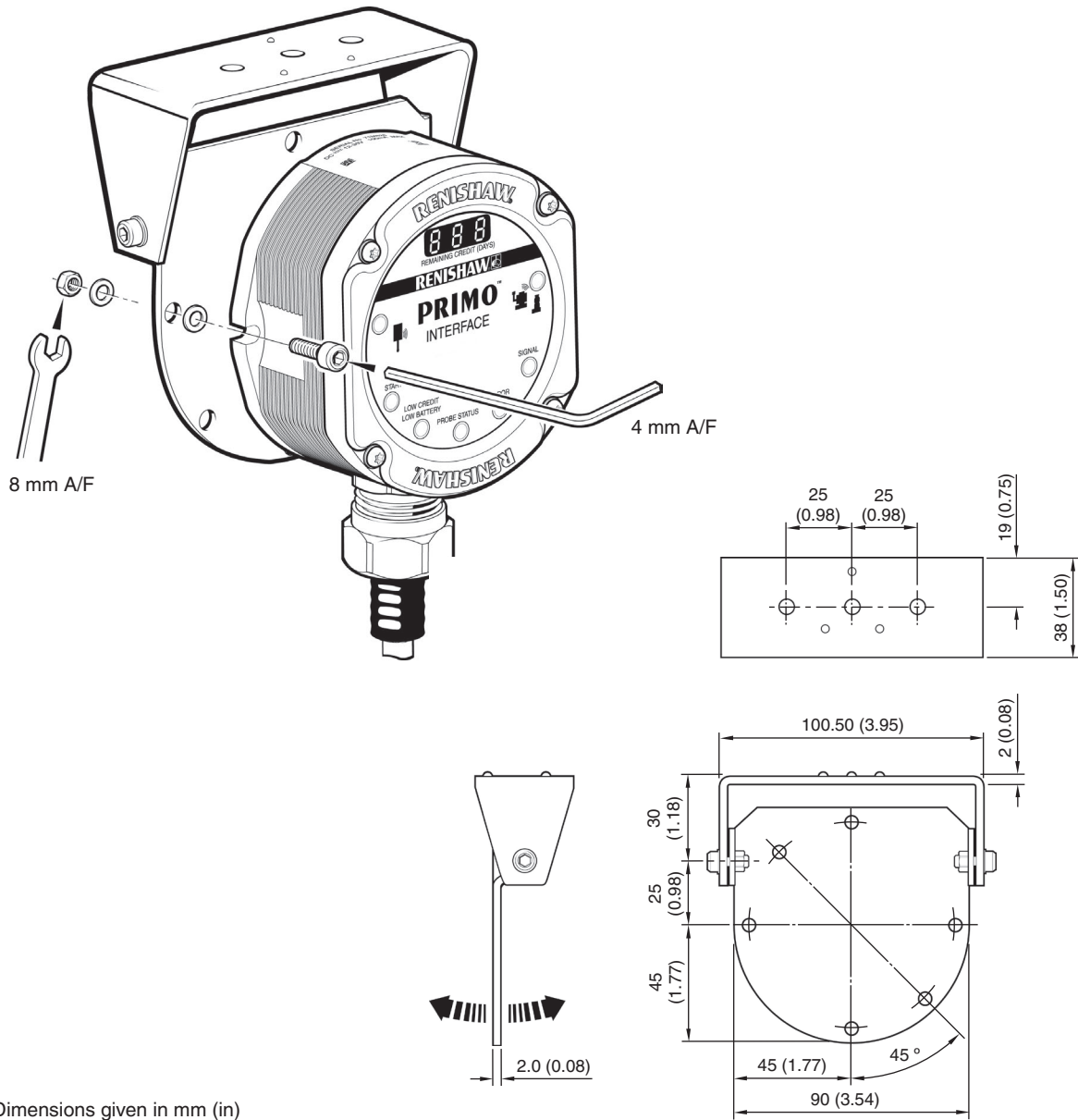

Interface wiring diagram

CAUTION: The power supply to the interface screen should be terminated at the machine ground (star point).

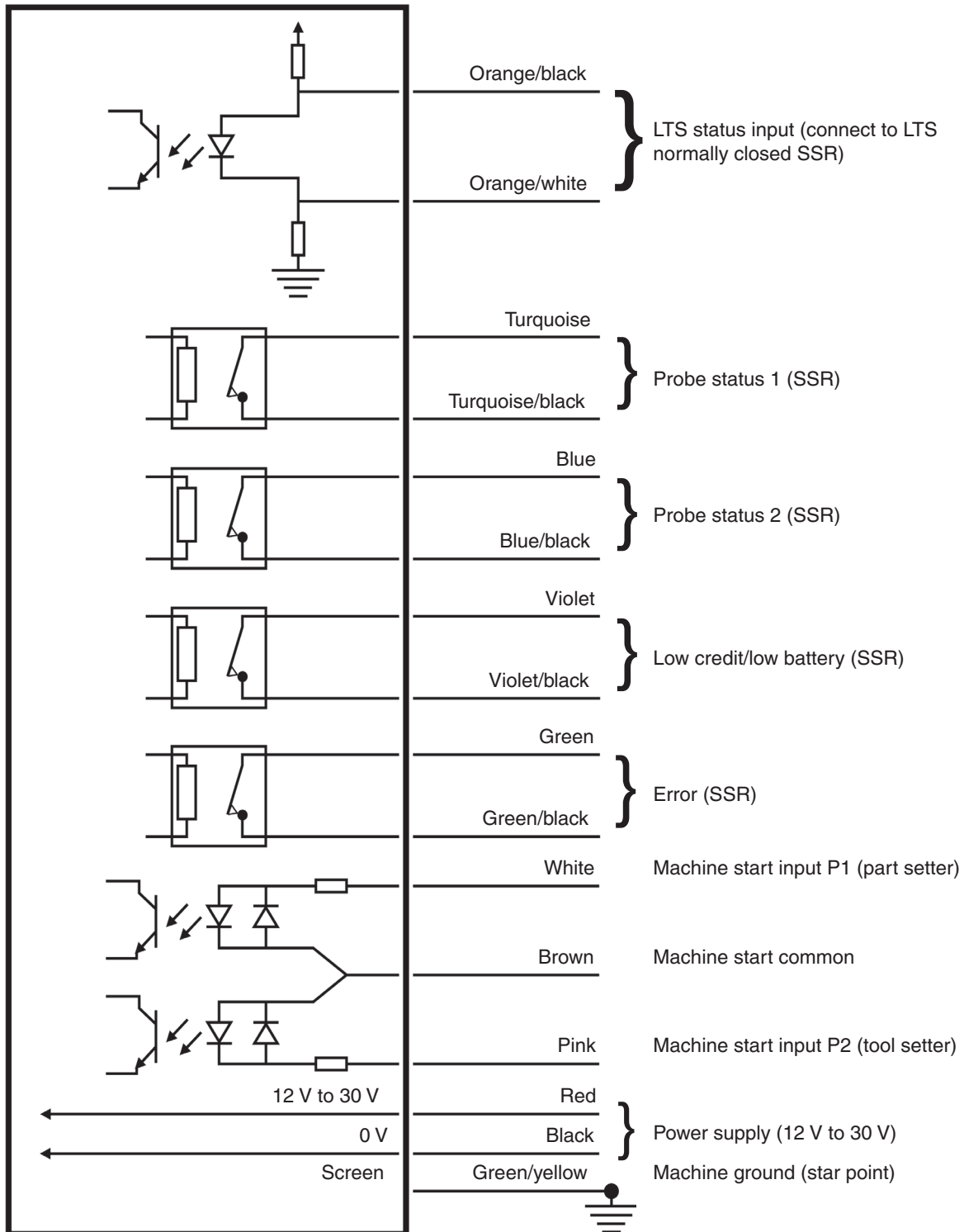

Interface cable

Cable specification

Length	8 m (26.25 ft)	Number of cores	15 cores and screen
Diameter	7.5 mm (0.29 in)	Dimensions of each core	15 cores and screen

A ferrule should be crimped onto each cable wire for a more positive connection at the terminal box.

A cable sealing gland prevents coolant and dirt from entering the interface.

The interface cable can be further protected by a flexible conduit.

Fitting flexible conduit

The recommended flexible conduit is Anamet Sealtite HFX (5/16 in) Polyurethane.

1. Slide nut B and the plastic olive onto the conduit.
2. Screw the conduit termination piece into the end of the conduit.
3. Fit the conduit to adaptor A and tighten nut B.

CAUTION: Failure to protect the cable can result in system failure due to either cable damage or coolant ingress through cores into the interface. System failure due to inadequate cable protection will invalidate the warranty.

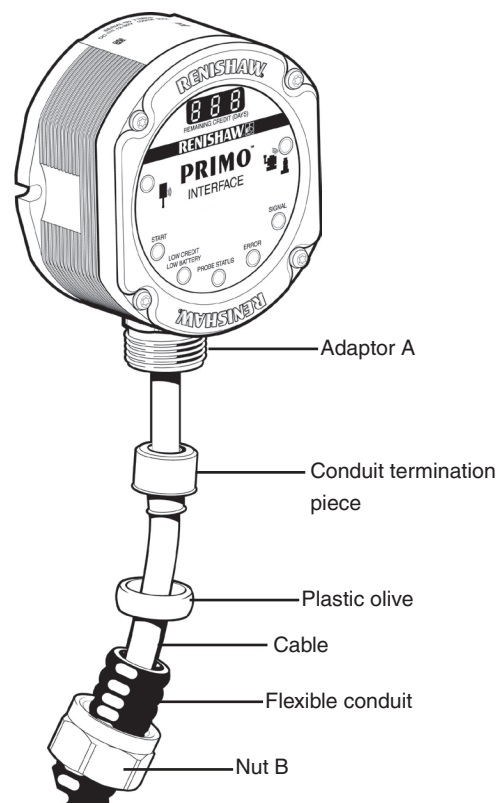

Interface screw torque values

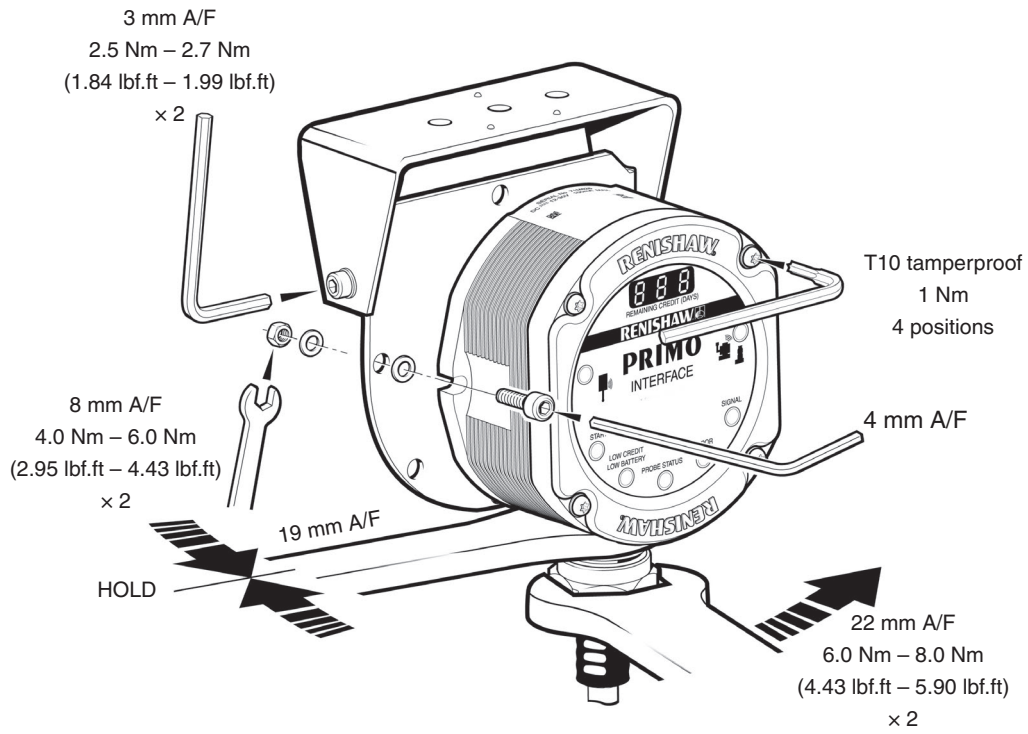

Calibrating the Primo equipment

Why calibrate?

The part setter and tool setter are just two components of the measurement system which communicates with the machine tool. Each part of the system can introduce a constant difference between the position that the stylus touches and the position that is reported to the machine. If either probe is not calibrated, this difference will appear as an inaccuracy in the measurement. Calibration of the probes allows the probing software to compensate for this difference.

During normal use, the difference between the touch position and the reported position does not change, but it is important that you calibrate your probes in the following circumstances:

- when a probe system is to be used for the first time;
- when the probe settings are changed;
- when a new stylus is fitted to the probe;
- when it is suspected that the stylus has become distorted or that the probe has crashed;
- at regular intervals to compensate for mechanical changes of your machine tool.

To ensure accurate results during use of the Primo system it is vital that the measuring feedrates used to set parts and tools are the same as the feedrates used to calibrate the part setter and the tool setter. Using different feedrates will produce deviations in the measurement results and could lead to inaccuracies in machining.

It is good practice to set the tip of the part setter stylus on centre, because this reduces the effect of any variation in spindle and tool orientation. For more information, see "Part setter stylus on-centre adjustment" on **page 5-6**. A small amount of run-out is acceptable and can be compensated for as part of the normal calibration process.

When your tool setter is assembled and mounted on the machine table, it is necessary to align the stylus face with the machine axes to avoid probing errors when setting tools. It is worth taking care with this operation – you should try to get the face aligned to within 0.015 mm for normal use. For more information, see "Tool setter stylus level setting" on **page 5-10**. This is achieved by manually adjusting the stylus with the adjusting screws provided, and using a suitable instrument such as a dial test indicator (DTI) clock mounted in the machine spindle.

Calibrating the part setter and tool setter together

GoProbe includes a cycle for calibrating the part setter and tool setter at the same time. It automatically stores calibration values for use during setting and measurement cycles. For more information, see the GoProbe pocket guide (available from your local Renishaw representative).

Alternatively the part setter or tool setter can be calibrated individually. This method is used when:

- using a non-standard stylus;
- only one probe is to be calibrated;
- accuracy of better than 10 µm is required;
- working on a 4-axis or 5-axis machine tool.

GoProbe training part calibration

An alternative to calibrating the part setter and tool setter together is to use the GoProbe training part calibration cycle, designed for customers who do not have a tool setter. The GoProbe training part is supplied with the GoProbe training kit and includes a calibration artefact that provides calibration results as accurately as a ring gauge.

The GoProbe training part calibration cycle will calibrate the part setter in X and Y. This should be used along with the length calibration cycle that will calibrate the part setter in Z. The GoProbe training part and length calibration cycles use single-line commands from GoProbe which make calibration quick and easy.

To find out more about GoProbe training part calibration and the GoProbe training kit visit www.renishaw.com/goprobe.

Calibrating the part setter only

Three different operations are to be used when calibrating the part setter. They are:

- calibrating either in a bored hole or on a turned diameter of known position;
- calibrating either in a ring gauge or on a datum sphere;
- calibrating the probe length.

Calibrating in a bored hole or on a turned diameter

Calibrating a probe, either in a bored hole or on a turned diameter of known size, automatically stores values for the offset of the stylus ball relative to the spindle centre line. The stored values are then used automatically in the measuring cycles.

Measured values are compensated by these values so that they are relative to the true spindle centre line.

Calibrating in a ring gauge or on a datum sphere

Calibrating a probe either in a ring gauge, or on a datum sphere with a known diameter, automatically stores one or more values for the radius of the stylus ball. The stored values are then used automatically by the measuring cycles to give the true size of the feature. The values are also used to give true positions of single surface features.

NOTE: The stored radius values are based on the true electronic trigger points. These values are different from the physical sizes.

Calibrating the probe length

Calibrating a probe on a known reference surface determines the length of the probe based on the electronic trigger point. The stored value for length is different from the physical length of the probe assembly. Additionally, the operation can automatically compensate for machine and fixture height errors by adjusting the probe length value that is stored.

Calibrating the tool setter only





The purpose of calibration is to establish the trigger point values of the measuring face of the tool setter's stylus under normal measuring conditions.

Calibration should be run at the same feedrate as probing.

The calibration values are stored in macro variables for computation of the tool size during tool setting cycles.

Values obtained are axis trigger positions (in machine co-ordinates). Any errors due to machine and probe triggering characteristics are automatically calibrated out in this way. These values are the electronic trigger positions under dynamic operating conditions and are not necessarily the true physical stylus face positions.

Part setter and tool setter LED guide





Key to the symbols	
	LED short flash
	LED double short flash
	LED medium flash
	LED long flash

Start-up



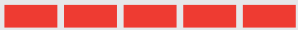



















LED colour	Status	Graphic hint
Red, green, blue	Newly changed battery or newly inserted credit token	

Acquisition mode

For more information, see "Acquisition method" on [page 5-25](#).



LED colour	Status	Graphic hint
5 green flashes	Acquisition prompt (seated)	
5 red flashes	Acquisition prompt (triggered)	
Flashing violet	Acquisition waiting	
Continuous violet	Interface identified	
Green for 5 seconds	Acquisition complete	

Operational mode (all signals repeat)

LED colour	Status	Graphic hint		
Flashing green	Equipment seated – good credit, good battery			
Flashing red	Equipment triggered *			
Flashing blue	Equipment seated – good credit, low battery			
Flashing yellow	Equipment seated – low credit, good battery			
Flashing blue and yellow	Equipment seated – low credit, low battery			 
Double flashing yellow	Equipment seated – very low credit	 	 	 









* When the probe is triggered, a flashing red signal overrides any other indication such as low credit or low battery. The status of these indicators can only be viewed when the probe is seated.

Errors

LED colour	Status	Graphic hint
Continuous violet	Contact Renishaw	
Continuous red	Battery dead	
Continuous yellow	Credit exhausted	

Credit transfer mode (part setter only)

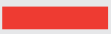
For more information, see "Credit transfer" on [page 5-32](#).

LED colour	Status	Graphic hint	
Flashing yellow and green	Credit transfer mode (repeats until mode change)		
Flashing yellow and red	Credit transfer unsuccessful (repeats 5 times)		
Flashing yellow and blue	Credit transfer successful (repeats 5 times)		
Flashing red and violet	Credit transfer mode – represents a lifetime system		





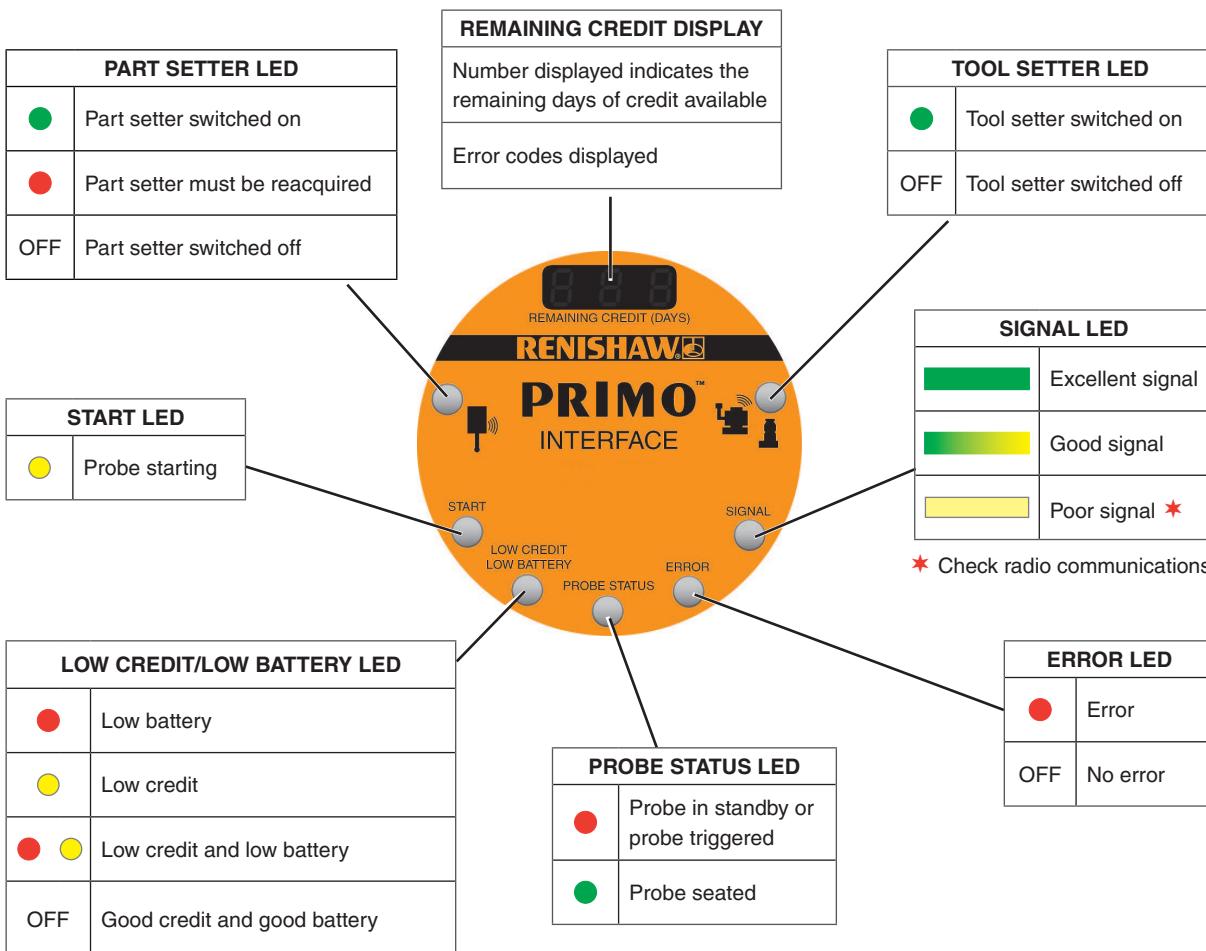



































































Interface LED signals

Key to LED symbols	
●	Solid
● ●	Flashing
▬	Gradient



Acquisition mode

The LEDs provide the following information during acquisition (partnership).

System status	Graphic display							Details
	Part setter	Start	Low credit/ low battery	Probe status	Error	Signal	Tool setter	
Interface in “Acquisition waiting” state	 						 	The part setter/tool setter LEDs flash yellow/off (at least once) for up to 11 seconds or until a part setter/tool setter is discovered.
Interface identifies part setter	 						 	The part setter LED flashes green for up to 3 minutes or until an “acquisition ready” message is received from the part setter.
Interface identifies tool setter	 						 	The tool setter LED flashes green for up to 3 minutes or until an “acquisition ready” message is received from the tool setter.
Part setter and tool setter identified	 						 	Both LEDs flash green for up to 3 minutes or until an “acquisition ready” message is received from the equipment.
The part setter is acquired (tool setter acquisition pending)							 	The part setter LED is on and the tool setter LED flashes for 3 minutes or until the tool setter is acquired.
Tool setter acquired (part setter acquisition pending)								The tool setter LED is on and the part setter LED flashes for 3 minutes or until the part setter is acquired.
Part setter acquired							 	The part setter LED stays on for 5 seconds.
Tool setter acquired								The tool setter LED stays on for 5 seconds.
Part setter and tool setter acquired								The part setter and tool setter LEDs stay on for 5 seconds.

Operational mode

The LEDs provide the following information during operational mode.

System status	Graphic display							Details
	Part setter	Start	Low credit/ low battery	Probe status	Error	Signal	Tool setter	
Standby	○	○	○	●	●	○	○	System in standby mode.
Start signal	○	●	○	●	●	○	○	When set to level start, the start LED will stay yellow until the part setter or tool setter starts. When set to pulsed start, the start LED will stay yellow until the equipment starts, or for up to 30 seconds. If the probe fails to start, check for a dead battery (see "Fault-finding" on page 7-1 , for further information).
Standby low credit	○	○	●	●	●	○	○	When no equipment is operating, the low credit/low battery LED will be yellow if credit is low.
Part setter on and seated	●	○	○	●	○	●	○	The part setter is not triggered on a surface.
Part setter on, seated with low credit	●	○	●	●	○	●	○	The part setter is not triggered on a surface but has low credit.
Part setter on, seated with low battery	●	○	●	●	○	●	○	The part setter is not triggered on a surface but has a low battery.
Part setter on, seated with low battery and low credit	●	○	● ●	●	○	●	○	The low credit/low battery LED will flash red and yellow while conditions persist.
Part setter on and triggered	●	○	○	●	○	●	○	The part setter stylus has touched a surface and has unseated.
Part setter on, seated with good signal	●	○	○	●	○	●	○	The signal LED is graded from green to yellow to show the part setter signal integrity.
Part setter triggered start (level start only)	●	○	○	●	●	●	○	If the part setter is triggered when it is started, the interface will stop the part setter from operating until it has returned to a seated position.

Error states

The LEDs provide the following error information.

System status	Graphic display							Details
	Part setter	Start	Low credit/ low battery	Probe status	Error	Signal	Tool setter	
New part setter acquisition required	●	○	○	●	●	○	○	If the part setter spin/M-code DIP switch is changed after it is acquired, the part setter will need to be reacquired or the switch must be changed back.
Tool setter on, attempted switch-on of part setter	● ○	○	○	●	●	○	●	The part setter LED will flash to indicate a multiple equipment error. The LED will continue to flash while conditions persist.
Attempted switch-on of both pieces of equipment simultaneously	● ○	○	○	●	●	○	● ○	The part setter and tool setter LEDs will flash to show a multiple equipment error.
System overcurrent	○	○	● ○	● ○	● ○	○	○	The low credit/low battery, status and error LEDs will flash. The error LEDs will continue to flash until the fault is cleared and the power is cycled.
Hardware validation failure	○	○	○	●	●	●	○	Contact Renishaw.

Interface digital display codes

Credit codes

 →  = Available credit in days
REMAINING CREDIT (DAYS) REMAINING CREDIT (DAYS)

 = Credit upgraded to unlimited (upgrade credit token)
REMAINING CREDIT (DAYS)

Error codes

E01 = Multiple M-code error

E02 = Multiple active equipment error

E08 = Acquisition required (incorrect DIP switch state for switch-on method)

E20 = Output overcurrent

Flashing codes

 = Credit transfer mode

 = Acquisition mode

All other codes should be reported to Renishaw.

Acquisition method

Part setter

Both the part setter and the tool setter can be partnered with the interface simultaneously.



Key to the symbols	
●	LED short flash
■	LED medium flash
■	LED long flash

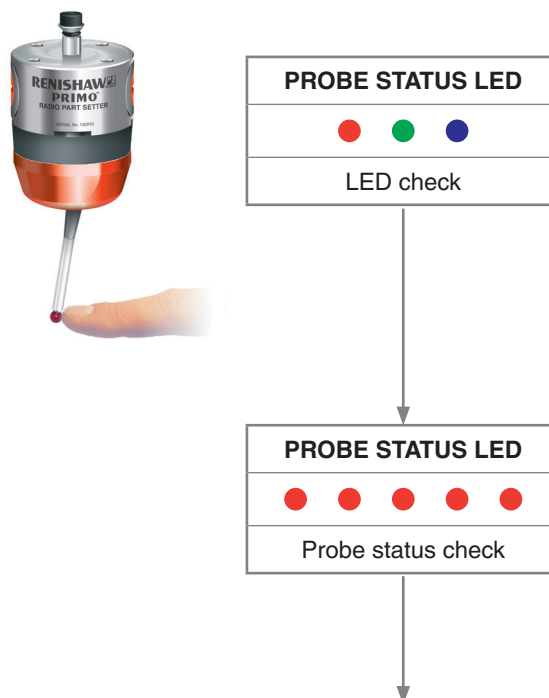

NOTE: The interface will be switched off and on again during the part setter acquisition.

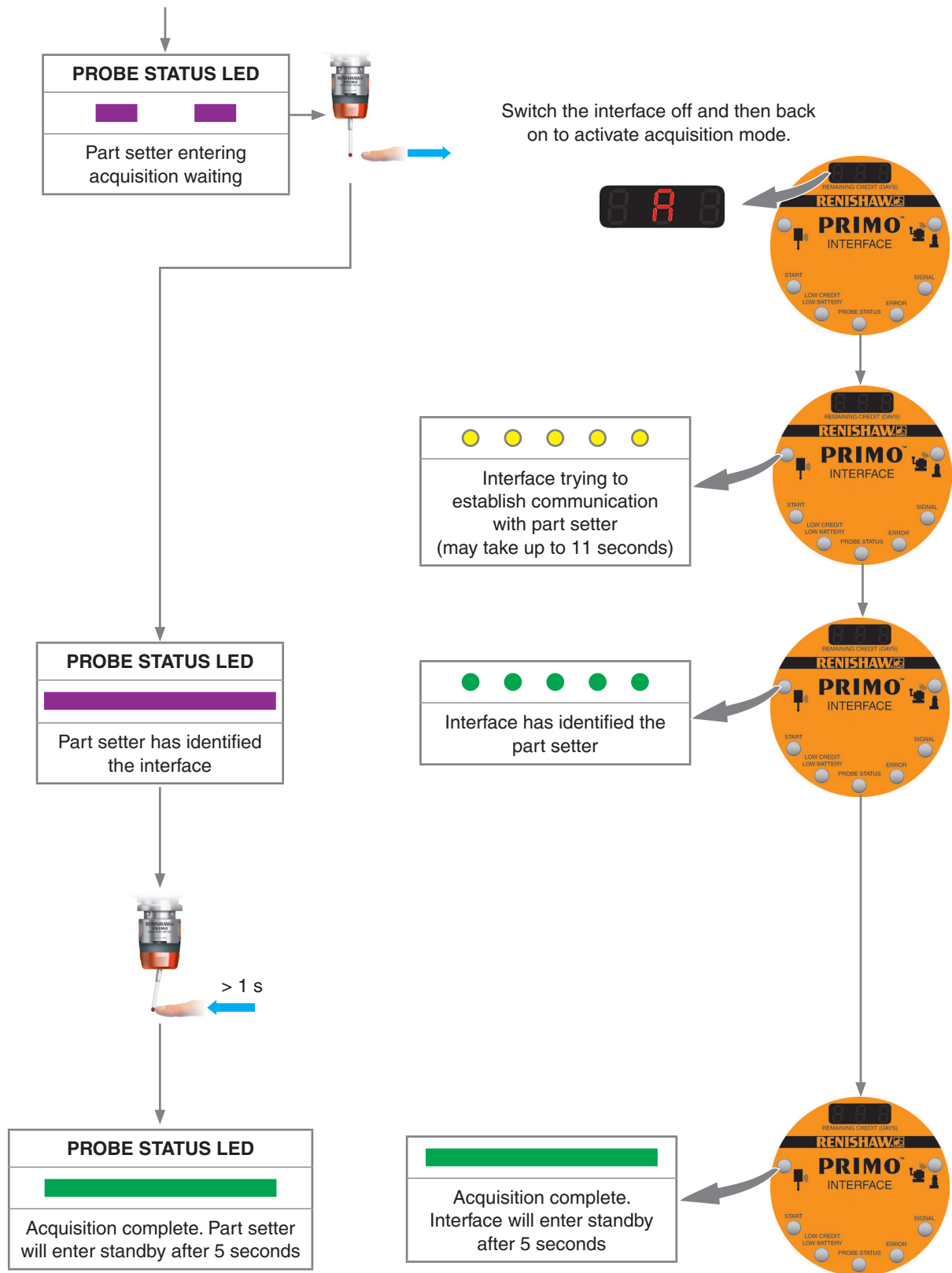



Tool setter



Key to the symbols	
	LED short flash
	LED medium flash
	LED long flash

NOTE: The interface will be switched off and on again during the tool setter acquisition.

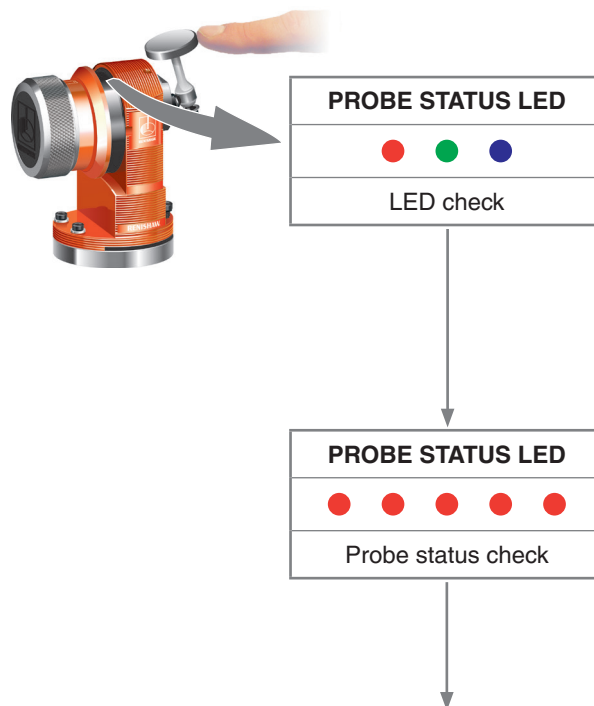

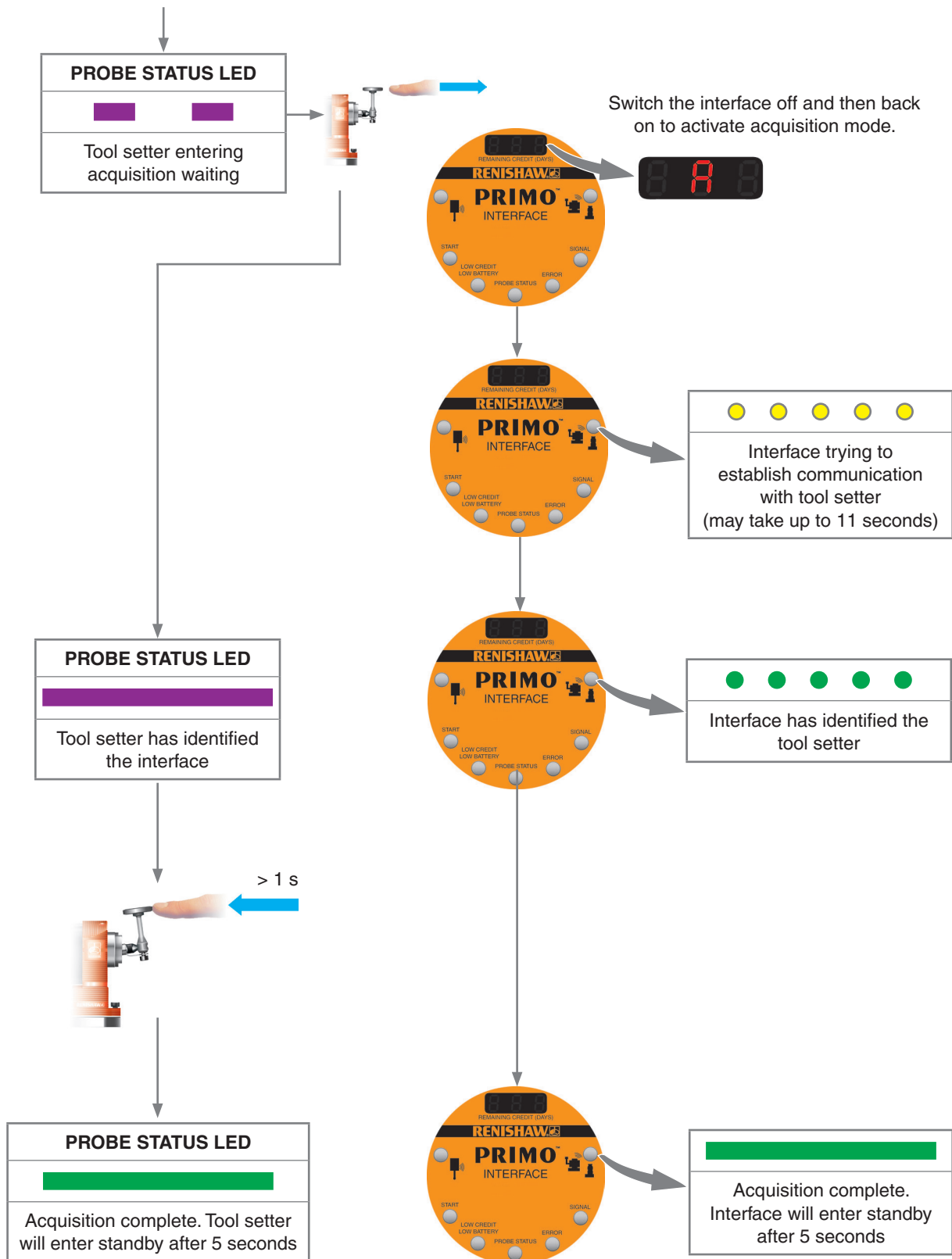

Installing the credit token cassette

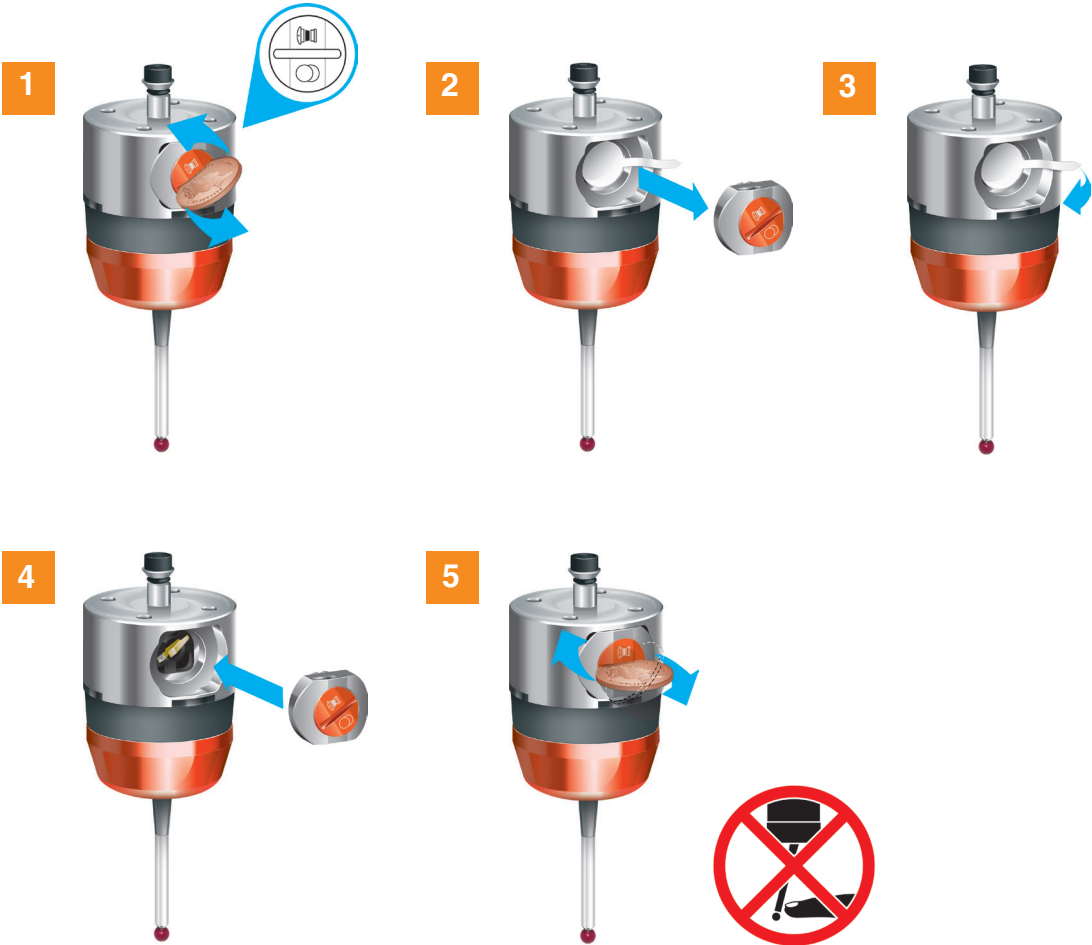

NOTE: The part setter automatically enters credit transfer mode. For more information, see "Credit transfer" on **page 5-32**.

Changing the credit token

NOTE: Ensure that the credit token is installed in the part setter in the orientation shown in step 4. Failure to do this will result in the credit not being transferred.

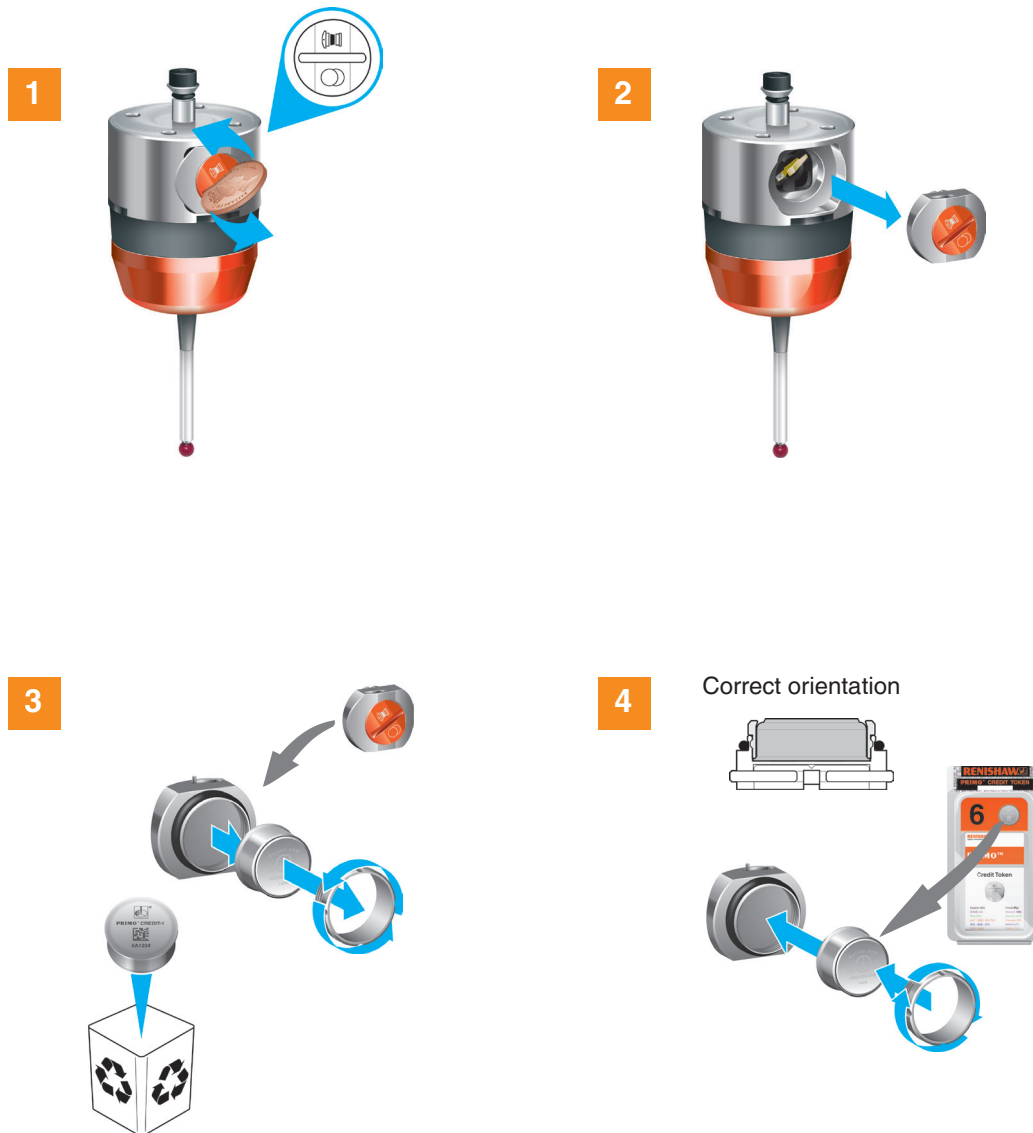

5



6



NOTE: The part setter automatically enters credit transfer mode. For more information, see "Credit transfer" on **page 5-32**.

Credit transfer

NOTES:

Once credit transfer has been initiated, it cannot be interrupted.

Once the credit has been transferred, do not remove the token from the part setter.

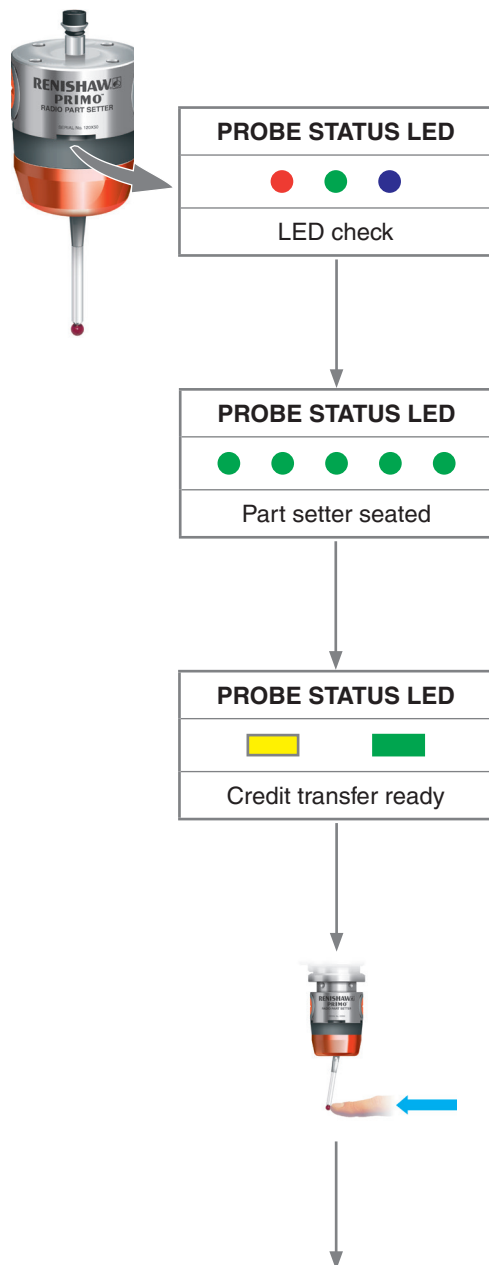

Key to the symbols	
●	LED short flash
■	LED medium flash
▬	LED long flash

NOTE: The interface must stay powered at all times during the credit transfer process.



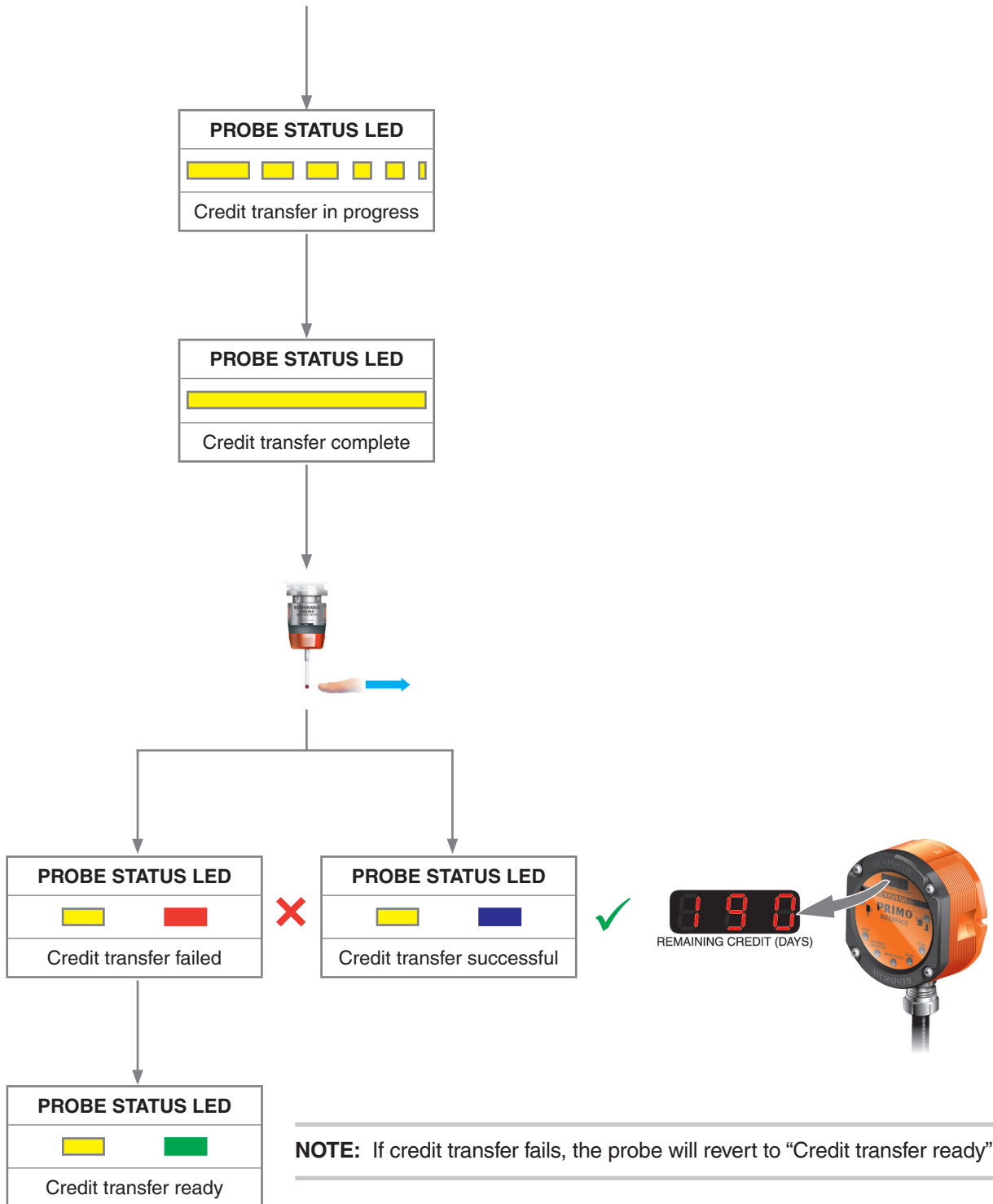

This page is intentionally left blank.

Maintenance

Introduction

You may undertake the maintenance routines described in these instructions; further dismantling and repair of Renishaw equipment must be carried out by an authorised Renishaw Service Centre.

Cleaning the equipment

Wipe the window of the part setter and the body shell of the tool setter with a clean cloth on a regular basis to remove machining residue.



Changing the battery

Part setter

See the table on **page 6-4** for a list of suitable battery types.

See "Safety" on **page 1-3**, for battery safety information.

NOTES:

Always ensure that the seal and mating surfaces are clean and free from dirt before reassembly.

After removing the old battery, wait at least 5 seconds before inserting the new battery.

If a dead battery is inadvertently inserted into the probe, the LEDs will remain a constant red or off.

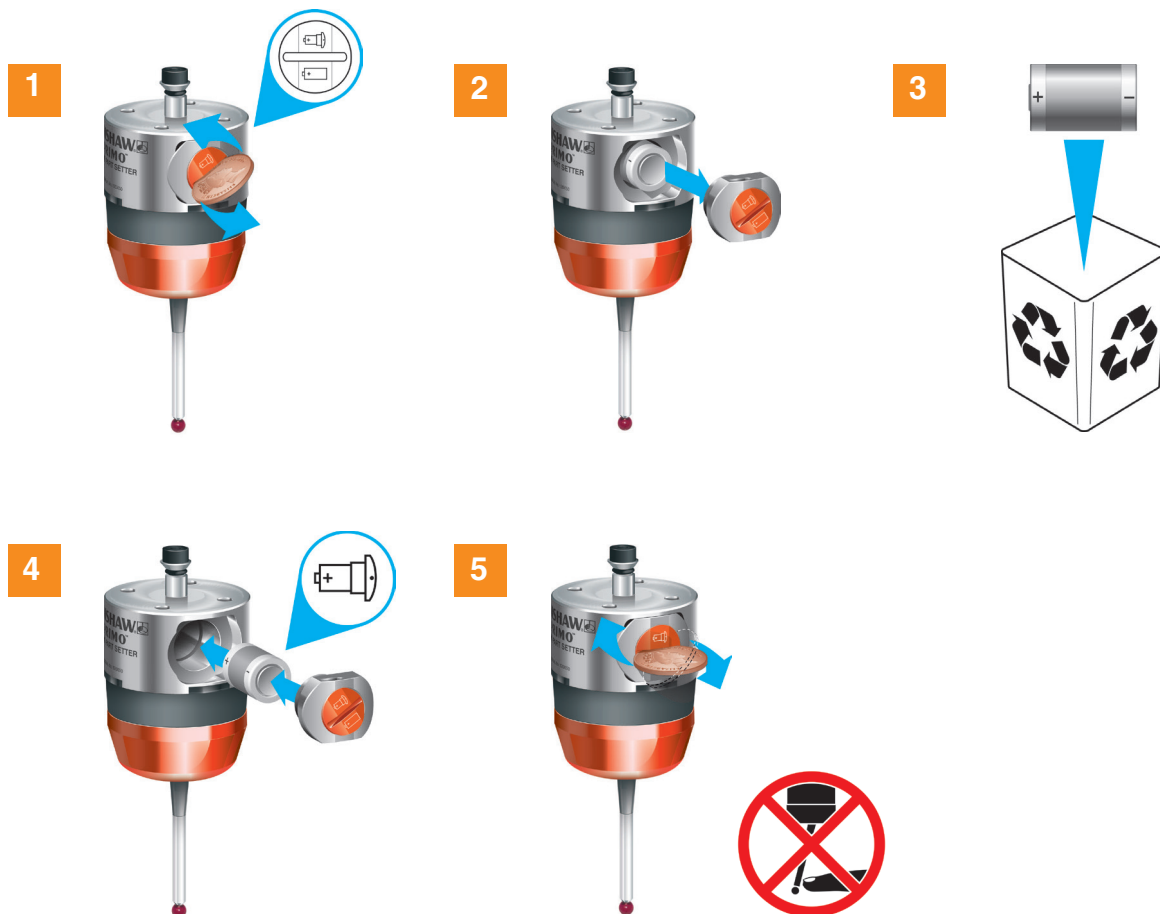

Tool setter

See the table on **page 6-4** for a list of suitable battery types.

See "Safety" on **page 1-3**, for battery safety information.

NOTES:

Always ensure that the seal and mating surfaces are clean and free from dirt before reassembly.

After removing the old battery, wait at least 5 seconds before inserting the new battery.

If a dead battery is inadvertently inserted into the probe, the LEDs will remain a constant red or off.

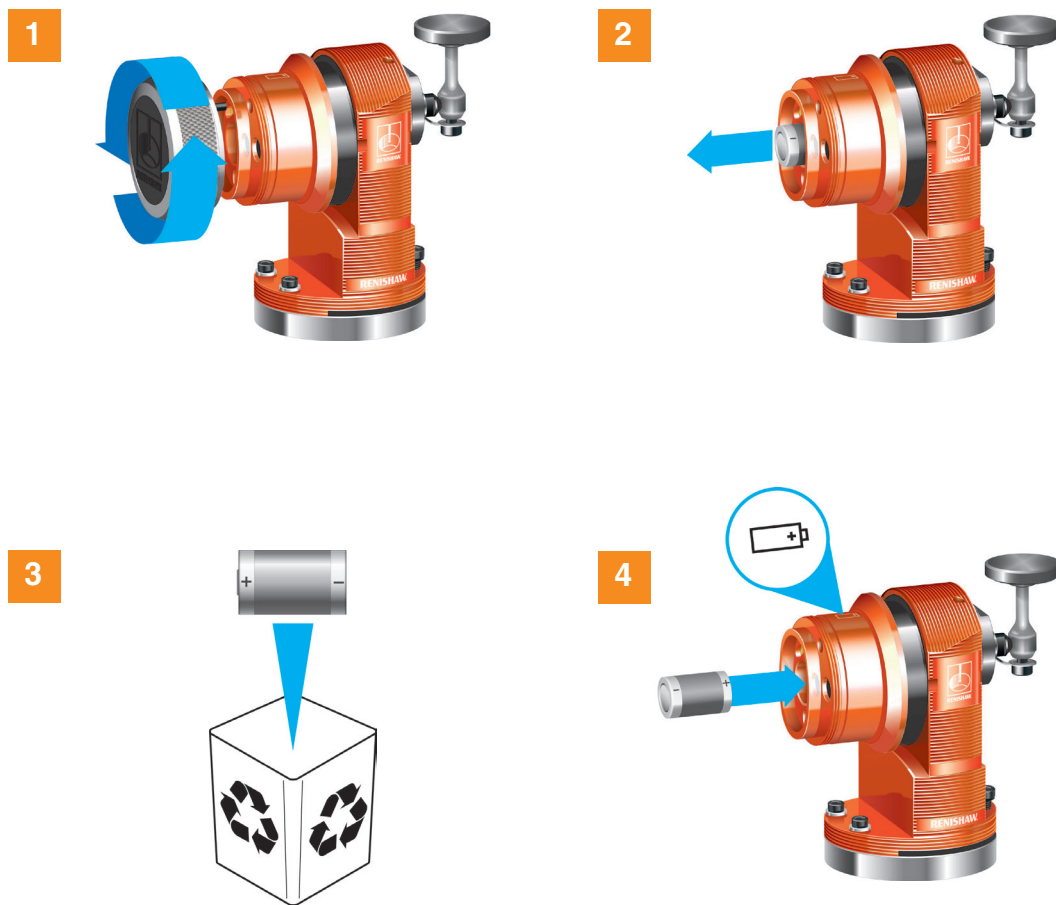

5

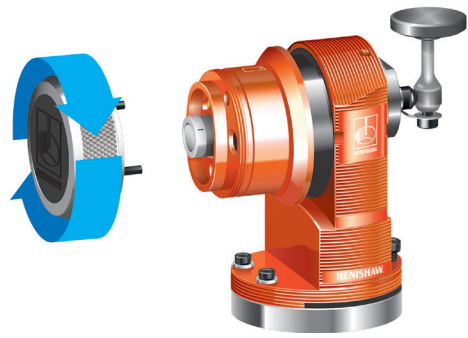

Battery types			
CR2 (3 V) lithium-manganese dioxide × 2		½ AA lithium-thionyl chloride × 1	
Energizer:	EL1 CR2	Saft:	LS 14250 C, LS 14250
Duracell:	Ultra CR2	Tadiran:	SL-750
		Xeno:	XL-050F

Interface cover

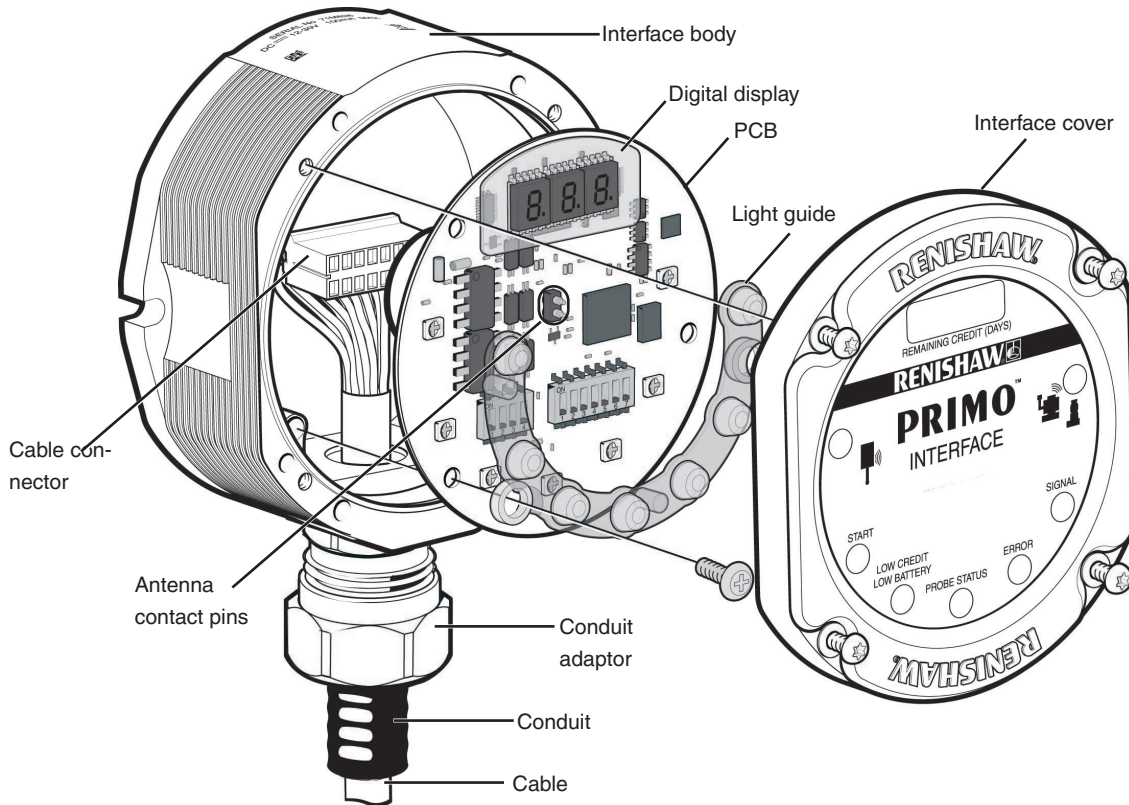

The front cover may be removed and replaced to change the configuration of the DIP switches.

Removing the interface cover



1. Clean thoroughly to ensure no debris or coolant enters the unit.
2. Unscrew (but do not remove) each captive screw and washer evenly from the cover using the T10 tamperproof key.
3. Using the T10 tamperproof key, tighten each captive screw to 1 Nm.

Routine tool setter maintenance

Ensure the tool setter is securely mounted and keep all electrical connections clean. Inspect the diaphragm seal once a month.

NOTE: In the event of the diaphragm seal being damaged, return the tool setter to your supplier for repair.

Inspecting the diaphragm seal



1 Remove the stylus/break stem assembly.



2 Remove the front cover.

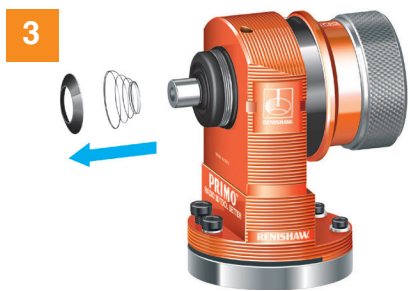

3 Remove the metal eyelid and spring.



4 Wash the inside of the probe with clean coolant.

5



Inspect the diaphragm seal for signs of piercing or damage.

6



If there is no damage, reassemble the tool setter.

This page is intentionally left blank.

Fault-finding

Part setter

Symptom	Cause	Action
The part setter fails to power up (no LEDs illuminated).	No credit token.	Insert a credit token (see page 5-29).
	The credit token was inserted incorrectly.	Check the credit token insertion and polarity (see page 5-30).
	Dead battery.	Change the battery (see page 6-2).
	Unsuitable battery.	Change the type of battery being used (see page 6-4).
	The battery was inserted incorrectly.	Check the battery insertion and polarity (see page 6-2).
	The battery was removed for too short a time and the part setter has not reset.	Remove the battery for a minimum of 5 seconds (see page 6-2).
	Poor contact between the battery cover mating surfaces and the contacts.	Remove any dirt and clean the contacts before reassembly (see page 6-2).
Reduced range.	There is local radio interference or obstruction.	Identify the source of interference or obstruction and remove it.
	Radio link failure or the part setter is out of range.	Check the position of the interface and remove any obstructions (see page 5-1).
The part setter crashes.	The workpiece is obstructing the path of the part setter.	Review the software and the program (refer to the programming manual).
	The part setter's length offset is missing.	Review the software and the offsets (refer to the programming manual).

Symptom	Cause	Action
Poor part setter repeatability and/or accuracy.	Debris on the part or the stylus.	Clean the part and the part setter's stylus.
	Poor tool change repeatability.	Recalibrate the part setter after each tool change (refer to the programming manual).
	Loose part setter mounting on the shank or loose part setter stylus.	Check the part setter has been mounted correctly, adjust if required and tighten the stylus as appropriate (see page 5-3 and page 5-1).
	Calibration is out of date causing the calibration values to be inaccurate.	Recalibrate the part setter (refer to the programming manual).
	An environmental or physical change (for example, significant temperature change, new stylus) within the machine has caused a discrepancy in the calibrated offsets.	Review the program and repeat the calibration routine (refer to the programming manual).
	Calibration and usage speeds are not the same.	Review the program and make the speeds the same (refer to the programming manual).
	Measurement occurs as the stylus leaves the surface.	Review the program (refer to the programming manual).
	Measurement occurs within the machine's acceleration and deceleration zone.	Review the part setter filter settings and the program to increase the back-off distance from the part (see page 3-5 and refer to the programming manual).
	The movement speeds are too fast or too slow.	Review the program and perform simple repeatability trials at various speeds (refer to the programming manual).
	Temperature variation causes machine and workpiece movement.	Minimise temperature changes (refer to your machine tool documentation).
	The machine tool is faulty.	Perform health checks on the machine tool (refer to your machine tool documentation).
Excessive machine vibration.	Enable the enhanced trigger filter and recalibrate the part setter. Eliminate vibrations. (See page 2-2 and refer to your machine tool documentation).	

Symptom	Cause	Action
The machine stops unexpectedly during a probing cycle.	Radio link failure or the part setter is out of range.	Check the position of the interface and remove any obstruction (see page 5-1).
	Interface or machine fault.	Check the interface error code (see page 5-24) and the machine user's guide (refer to your machine tool documentation).
	Dead battery.	Change the battery (see page 6-2).
	Exhausted credit (a yellow LED will be shown on the part setter; see page 5-20).	Insert a new credit token into the part setter (see page 5-32).
	The part setter is unable to find the target surface.	Check that the part is correctly positioned and the stylus has not broken (see page 5-2 and page 5-3).
	The stylus was not given sufficient time to settle from a rapid deceleration.	Add a short dwell before the probing move (the length of dwell will depend on the stylus length and rate of deceleration). The maximum dwell is one second (refer to the programming manual).
	A false probe trigger.	Enable the enhanced trigger filter (see page 2-2 and page 3-5) and recalibrate the part setter (refer to the programming manual).
The interface error LED is lit during the probing cycle.	The part setter is not switched on or it is in hibernation mode.	Review the switch-off method (see page 2-2) and the program.
	Radio link failure or the part setter is out of range.	Check the position of the interface (see page 5-2) and remove any obstructions.
	Dead battery.	Change the battery (see page 6-2).
	The part setter and interface are not partnered.	Partner the part setter and the interface (see page 5-25).
The interface low credit/low battery LED is lit yellow.	There is low credit in the system (a flashing yellow LED will be shown on the part setter; see page 5-19).	Replace the credit token in the part setter soon (see page 5-32).
The interface low credit/low battery LED is lit red.	The part setter battery is low (a flashing blue LED will be shown on the part setter; see page 5-19).	Replace the battery in the part setter soon (see page 6-2).

Symptom	Cause	Action
The interface low credit/low battery LED is flashing yellow/red.	There is low credit in the system and the part setter battery is low (a flashing yellow/blue LED will be shown on the part setter; see page 5-18).	Replace the credit token (see page 5-32) and the battery (see page 6-2) in the part setter soon.
The part setter fails to switch on.	No credit token.	Insert a credit token (see page 5-30).
	Exhausted credit (a yellow LED will be shown on the part setter; see page 5-19).	Insert a new credit token into the part setter (see page 5-30).
	The credit token was inserted incorrectly.	Check the credit token insertion and polarity (see page 5-30).
	Dead battery.	Change the battery (see page 6-2).
	The battery was inserted incorrectly.	Check the battery insertion and polarity (see page 6-2).
	The part setter is out of range.	Check the position of the part setter and the interface (see page 5-2).
	No interface "start/stop" signal (radio-on method only).	Check the interface for a yellow start LED (see page 5-20).
	Incorrect spin speed (spin-on method only).	Check the spin speed and duration (see page 2-2).
	Incorrect switch-on method configured.	Check the configuration and alter as required (see page 2-2).
Machine raises alarm during cycle and stops.	The part setter fails to switch off after the cycle is stopped.	Either reset the alarm, enter the required M-code or wait for the part setter to time out (90 minutes after last probing cycle) (refer to the programming manual).
	The part setter is out of range and it cannot be switched off.	Move the part setter into the range of the interface or the part setter will enter standby mode after 30 seconds and hibernation mode after a further 30 seconds if no signal is received.

Symptom	Cause	Action
The part setter LED does not correspond to the interface LEDs.	The part setter is not switched on or it is in hibernation mode.	Review the switch-on setting and change as required (see page 2-2).
	Radio link failure or the part setter is out of range.	Check the position of the part setter and the interface (see page 5-2).
	Dead battery.	Change the battery (see page 6-2).
	Exhausted credit (a yellow LED will be shown on the part setter; see page 5-19).	Insert a new credit token into the part setter (see page 5-32).
	The part setter and interface are not partnered.	Partner the part setter and the interface (see page 5-25).
The part setter fails to switch off.	Incorrect switch-off method configured.	Check the configuration and alter as required (see page 2-2).
	There is no interface “start/stop” signal (radio-on method only).	Check the interface for a yellow start LED (see page 5-20).
	The spin speed is incorrect (spin-on method only).	Check the spin speed (see page 2-2 and refer to the programming manual).
	Radio link failure or the part setter is out of range.	Check the position of the interface and remove any obstructions (see page 5-1).

Tool setter

Symptom	Cause	Action
The tool setter fails to power up (LED not illuminated).	Dead battery.	Change the battery (see page 6-2).
	Unsuitable battery.	Change the type of battery being used (see page 6-5).
	The battery is inserted incorrectly.	Check the battery insertion and polarity (see page 6-3).
	Poor contact between the battery cassette mating surfaces and the contacts.	Remove any dirt and clean the contacts before reassembly (see page 6-3).
The tool setter fails to switch on.	Dead battery.	Change the battery (see page 6-2).
	The battery is inserted incorrectly.	Check the battery insertion and polarity (see page 5-27).
	Exhausted credit (a yellow LED will be shown on the tool setter; see page 5-18).	Insert a new credit token into the part setter (see page 5-30).
	Radio link failure or the tool setter is out of range.	Check the position of the tool setter and the interface (see page 5-19).
	No interface “start/stop” signal.	Check the interface for a yellow start LED (see page 5-19).
	The tool setter is in hibernation mode.	Ensure the tool setter is in range and wait up to 30 seconds, then resend the switch-on signal (see page 5-19).
The machine stops unexpectedly during a probing cycle.	Radio link failure or the tool setter is out of range.	Check the position of the tool setter and the interface (see page 5-19).
	Interface or machine fault.	Check the interface error code (see page 5-23) and the machine tool user guide.
	Dead battery.	Change the battery (see page 6-2).
	Exhausted credit (a yellow LED will be shown on the tool setter; see page 5-18).	Insert a new credit token into the part setter (see page 5-30).
	False trigger.	Enable the enhanced trigger filter (see page 2-2) and recalibrate the tool setter (refer to the programming guide).

Symptom	Cause	Action
Poor tool setter repeatability and/or accuracy.	Debris on the tool or the stylus.	Clean the tool setter and the stylus (see page 6-1).
	Loose tool setter mounting on the machine bed or a loose stylus.	Check and tighten as appropriate (see page 5-7 and page 5-9).
	Excessive machine vibration.	Enable the enhanced trigger filter (see page 2-2) and eliminate any vibrations (refer to the programming manual).
	Calibration is out of date causing the calibration values to be inaccurate.	Recalibrate the tool setter (refer to the programming manual).
	An environmental or physical change (for example, significant temperature change, new stylus) within the machine has caused a discrepancy in the calibrated offsets.	Review the program and repeat the calibration (refer to the programming manual).
	The calibration and measurement speeds are not the same.	Review the program and make the speeds the same (refer to the programming manual).
	Measurement occurs as the tool leaves the stylus.	Review the program (refer to the programming manual).
	Measurement occurs within the machine's acceleration or deceleration zone.	Check the tool setter filter settings and the program to increase the back-off distance of the tool from the stylus (see page 2-2 and refer to the programming manual).
	The measurement speed is too high.	Review the program and perform simple repeatability trials at various speeds (refer to the programming manual).
	Temperature variation causes machine and tool movement.	Minimise temperature variation (refer to the machine tool documentation).
The machine tool is faulty.	Perform health checks on the machine tool (refer to the machine tool documentation).	

Symptom	Cause	Action
The tool setter LED does not correspond to the interface LEDs.	Radio link failure or the tool setter is out of range.	Check the position of the tool setter and the interface (see page 5-2).
	The tool setter has been enclosed or shielded by metal.	Remove the obstruction.
	The tool setter and interface are not partnered.	Partner the tool setter and the interface (see page 6-2).
The interface error LED is lit.	Dead battery	Change the battery (see page 5-27).
	The tool setter is not switched on or it is in hibernation mode.	Review the program (refer to the programming manual).
	Radio link failure or the tool setter is out of range.	Check the position of the tool setter and the interface (see page 5-2).
	The tool setter and interface are not partnered.	Partner the tool setter and the interface (see page 5-25).
The interface low credit/low battery LED is lit yellow.	There is low credit in the system (a flashing yellow LED will be shown on the tool setter; see page 5-18).	Replace the credit token in the part setter soon (see page 5-30).
The interface low credit/low battery LED is lit red.	The tool setter battery is low (a flashing blue LED will be shown on the tool setter; see page 5-18).	Replace the battery in the tool setter soon (see page 7-6).
The interface low credit/low battery LED is flashing yellow/red.	There is low credit in the system and the tool setter battery is low (a flashing yellow/blue LED will be shown on the tool setter; see page 5-18).	Replace the credit token in the part setter and the battery in the tool setter soon (see page 5-30 and page 7-6).
Reduced range.	There is local radio interference.	Identify the source of interference and remove it.
	Radio link failure or the tool setter is out of range.	Check the position of the tool setter and the interface (see page 5-2).

Symptom	Cause	Action
The spindle or tool crashes into the tool setter.	The tool length offset is incorrect.	Review the tool offsets (refer to the programming manual).
The tool setter fails to switch off.	No interface “start/stop” signal.	Check the interface for a yellow start LED (see page 5-19).
	Radio link failure or the tool setter is out of range.	Check the position of the tool setter and the interface (see page 5-2).
Machine raises alarm during cycle and stops.	The tool setter fails to switch off after the cycle is stopped.	Either reset the alarm, enter the required M-code or wait for the tool setter to time out (90 minutes after last probing cycle). (refer to the programming manual).
	The tool setter is out of range and it cannot be switched off.	The tool setter will enter standby mode after 30 seconds and hibernation mode after a further 30 seconds if no signal is received.
	Radio link failure or the tool setter is out of range.	Check the position of the tool setter and the interface (see page 5-2).

Interface

Symptom	Cause	Action
No LEDs lit on the interface.	No power to the interface.	Check the interface wiring (see page 5-13).
The interface status LED does not correspond to the selected probe LEDs.	Radio link failure or the selected probe is out of the interface range.	Check the position of the selected probe and the interface (see page 5-2).
	The selected probe has been enclosed or shielded by metal.	Remove the obstruction.
	The selected probe is not partnered with the interface.	Partner the selected probe to the interface (see page 5-25 and page 5-27).
The interface probe status LED is continually lit red.	Radio link failure or the selected probe is out of the interface range.	Check the position of the selected probe and the interface (see page 5-2).
The interface low credit/low battery LED is lit yellow.	There is low credit in the system (a flashing yellow LED will be shown on the selected probe; see page 5-18).	Replace the credit token in the part setter soon (see page 5-30).
The interface low credit/low battery LED is lit red.	The selected probe's battery is low (a flashing blue LED will be shown on the selected probe; see page 5-18).	Replace the battery as required (see page 6-2 and page 5-27).
The interface low credit/low battery LED is flashing yellow/red.	There is low credit in the system and the selected probe's battery is low (a flashing yellow/blue LED will be shown on the selected probe; see page 5-18).	Replace the credit token soon and replace the battery as required (see page 5-30 , page 6-2 and page 5-27).
The interface error LED is lit during the probing cycle.	Radio link failure or the selected probe is out of the interface range.	Check the position of the selected probe and the interface (see page 5-19).
	Dead battery in selected probe.	Check battery and replace as required (see page 6-2 and page 5-27).
	Selected probe and interface are not partnered.	Partner selected probe and interface (see page 5-25 and page 5-27).
	Hardware fault or electrical issue.	Review LED signals and error codes (see page 5-19 to page 5-23).
Multiple interface LEDs are flashing red.	Wiring fault.	Check the error codes, wiring and restart the machine (see page 5-13 , page 5-23 and refer to your machine tool documentation).
Reduced range.	Local radio interference.	Identify the interference and remove it.

Parts list

Type	Part number	Description
Primo™ Radio Part Setter	A-5471-2011	Part setter with stylus, battery and product card.
Primo Radio 3D Tool Setter	A-5472-2001	Tool setter with disc stylus, battery and product card.
Primo Interface	A-5473-0049	Interface with 8 m (26.2 ft) cable, tool kit and product card.
LTS	A-5475-0001	LTS with 8 m (26.2 ft) cable and product card
GoProbe software	Contact Renishaw	GoProbe software package with cycles for part setting, tool setting and calibration.
GoProbe training kit	Contact Renishaw	GoProbe training kit with pocket guide, GoProbe training part, e-learning course and quick-reference tool.
Primo 6-Month Credit Token	A-5474-0006	6-month credit token and instruction leaflet.
Primo Upgrade Credit Token	A-5474-0099	Upgrade credit token and instruction leaflet.
Battery	P-BT03-0014	½ AA lithium-thionyl chloride 3.6 V battery.
Battery	P-BT03-0010	CR2 lithium-manganese dioxide 3 V battery.
Stylus	A-5000-3709	PS3-1C ceramic stylus, 50 mm long with Ø6 mm ball, for the part setter.
Stylus	A-5472-3000	26 mm diameter disc stylus, tungsten carbide with break stem for the tool setter.
Weak link	A-2085-0068	Weak link (× 2) and 5 mm A/F spanner for the part setter.
Tool setter break stem kit	A-5472-3003	Kit comprising: Break stem (× 2); captive link; support bar; M4 screws (× 2); M4 grub screws (× 3); 2 mm and 3 mm A/F hexagon keys and 5 mm A/F spanner.
Stylus tool	M-5000-3707	Tool for tightening and releasing styli.
Part setter tool kit	A-4071-0060	Probe setter too kit comprising: Stylus tool; 2 mm A/F hexagon key, M4 cone point grub screws (× 2) and M4 flat point grub screws (× 4).
Tool setter tool kit	A-5472-0060	Tool setter tool kit comprising: Break stem; captive link (× 2); M4 screws (× 2); M4 grub screws (× 3); 2 mm, 3 mm and 4 mm A/F hexagon keys and 5 mm A/F spanner.

Type	Part number	Description
Interface tool kit	A-5473-0300	Interface tool kit comprising: T10 tamperproof key; 4 mm A/F hexagon key; ferrules (× 16); M5 screws (× 2); M5 nuts (× 2) and M5 washers (× 4).
Credit token cassette	A-5471-3000	Replacement credit token cassette for the part setter.
Battery cover	A-5471-3001	Replacement battery cover for the part setter.
Battery cover	A-5472-3001	Replacement battery cover for the tool setter.
Battery cover O-rings	A-5471-3002	Replacement O-rings for the part setter battery cover (× 2 needed).
Battery cover O-ring	A-5472-3002	Replacement O-ring for the tool setter battery cover.
Mounting bracket	A-2033-0830	Mounting bracket with fixing screws, washers and nuts for the interface.
Conduit kit	A-4113-0306	Conduit kit with 1 m (3.28 ft) of polyurethane conduit and bulkhead connector (M16 thread) for the interface.
Replacement window	A-5473-0305	Replacement window for the interface.
Panel-mount kit	A-5473-0315	Kit for mounting the interface in the machine panel rather than on the mounting bracket.
Publications. These can be downloaded from our website at www.renishaw.com/primodownloads		
Primo system	H-5470-8504	Installation guide: for set-up of the Primo system.
Data sheet	H-5470-8200	Data sheet: Technical information and specifications for the Primo system.
Programming manual	H-5990-8600	Programming manual: For instructions on how to use GoProbe software.
Styli	H-1000-3200	Technical specifications guide: Styli and accessories – or visit our Online store at www.renishaw.com/shop .
Taper shanks	H-2000-2011	Data sheet: taper shanks for machine tool probes.

This page is intentionally left blank.

www.renishaw.com/primo



#renishaw

 +44 (0) 1453 524524

 uk@renishaw.com

© 2015–2022 Renishaw plc. All rights reserved. This document may not be copied or reproduced in whole or in part, or transferred to any other media or language by any means, without the prior written permission of Renishaw.

RENISHAW® and the probe symbol are registered trade marks of Renishaw plc. Renishaw product names, designations and the mark 'apply innovation' are trade marks of Renishaw plc or its subsidiaries. Other brand, product or company names are trade marks of their respective owners.

WHILE CONSIDERABLE EFFORT WAS MADE TO VERIFY THE ACCURACY OF THIS DOCUMENT AT PUBLICATION, ALL WARRANTIES, CONDITIONS, REPRESENTATIONS AND LIABILITY, HOWSOEVER ARISING, ARE EXCLUDED TO THE EXTENT PERMITTED BY LAW. RENISHAW RESERVES THE RIGHT TO MAKE CHANGES TO THIS DOCUMENT AND TO THE EQUIPMENT, AND/OR SOFTWARE AND THE SPECIFICATION DESCRIBED HEREIN WITHOUT OBLIGATION TO PROVIDE NOTICE OF SUCH CHANGES.

Renishaw plc. Registered in England and Wales. Company no: 1106260. Registered office: New Mills, Wotton-under-Edge, Glos, GL12 8JR, UK.

Part no.: H-5470-8504-04-A

Issued: 12.2022